

DESCRIPTION	REVISIONS	DATE
ADDED GENERAL NOTE L		7/08/2011
MODIFIED SIGNS		4/10/2012

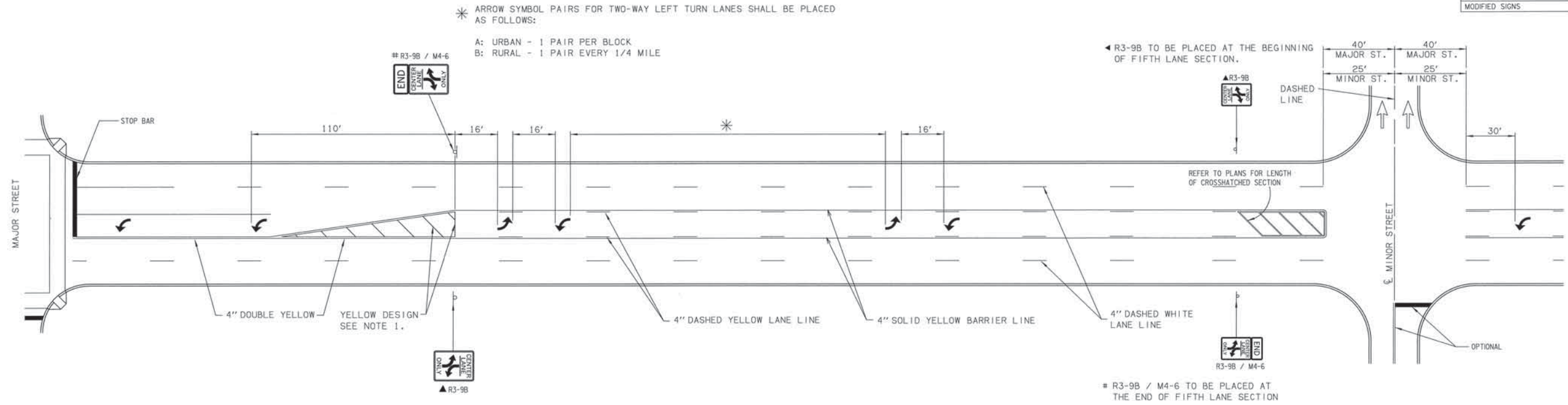

FIFTH LANE PAVEMENT MARKING DETAIL (URBAN)

GENERAL NOTE

- 1. WIDTH OF DIAGONALS ARE AS FOLLOWS:
 ≥ 45 MPH - 12" WIDE
 < 45 MPH - 8" WIDE

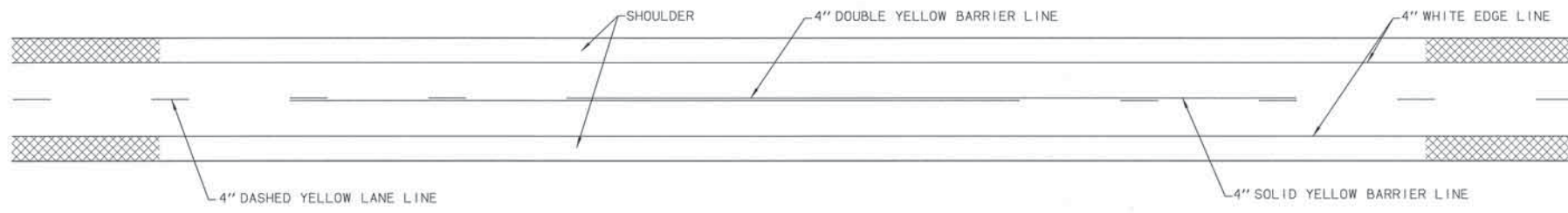

TWO LANE RURAL ROADWAY PAVEMENT MARKINGS

BASIS OF PAYMENT		
ITEM NO.	ITEM	UNIT
854(A)	TRAFFIC STRIPE (PAINT) (4" WIDE)	LF
854(B)	TRAFFIC STRIPE (PAINT) (ARROW, WORDS, OR SYMBOLS)	EA
855(A)	TRAFFIC STRIPE (PLASTIC) (4" WIDE)	LF
855(A)	TRAFFIC STRIPE (PLASTIC) (6" WIDE)	LF
855(A)	TRAFFIC STRIPE (PLASTIC) (8" WIDE)	LF
855(A)	TRAFFIC STRIPE (PLASTIC) (24" WIDE)	LF
855(B)	TRAFFIC STRIPE (PLASTIC) (ARROW)	EA
856(A)	TRAFFIC STRIPE (MULTI-POLYMER) (4" WIDE)	LF
856(A)	TRAFFIC STRIPE (MULTI-POLYMER) (6" WIDE)	LF
856(A)	TRAFFIC STRIPE (MULTI-POLYMER) (8" WIDE)	LF
856(A)	TRAFFIC STRIPE (MULTI-POLYMER) (24" WIDE)	LF
856(B)	TRAFFIC STRIPE (MULTI-POLYMER) (SYMBOLS, WORDS, ETC)	EA



APPROVED BY TRAFFIC ENGINEER: *[Signature]* DATE: 4/9/12

TRAFFIC STANDARD
 PAVEMENT MARKING
 (FIFTH LANE AND TWO LANE RURAL)

REVISIONS	
DESCRIPTION	DATE

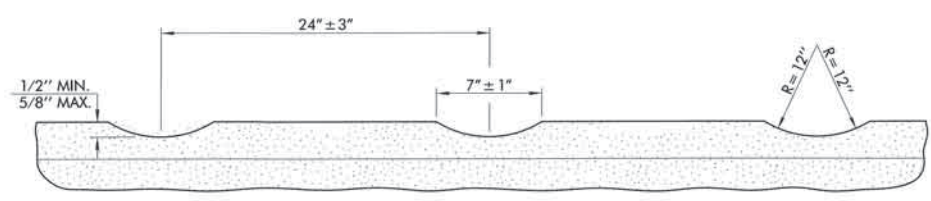
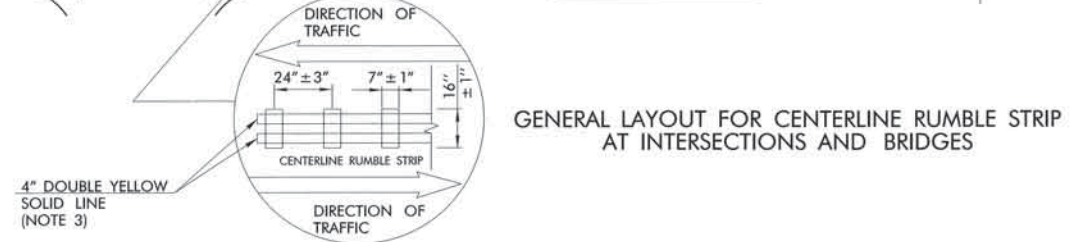
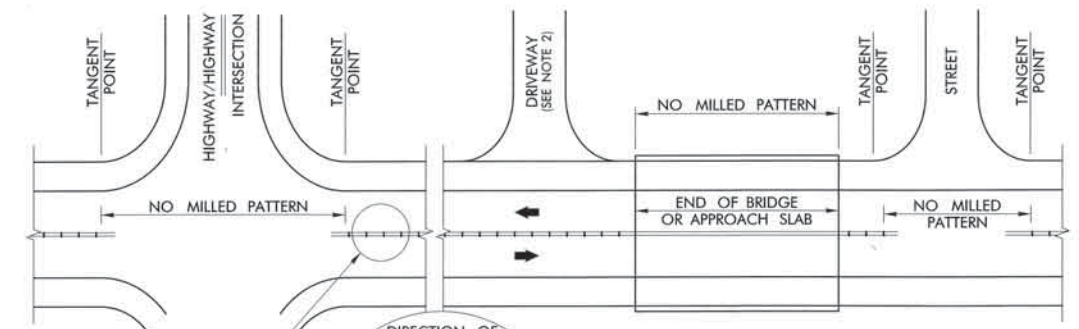

TYPICAL SECTION THROUGH CONTINUOUS MILLED PATTERN CENTERLINE RUMBLE STRIP (SEE NOTE 4 FOR ADDITIONAL APPLICATIONS)

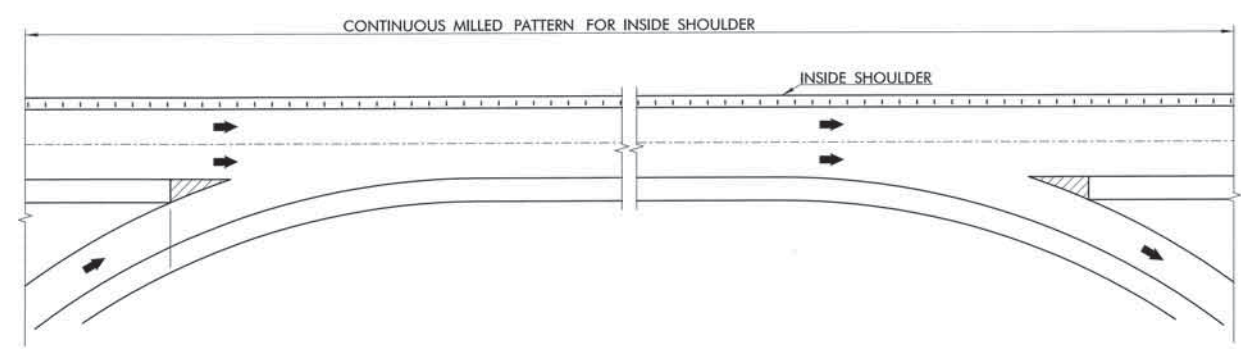

GENERAL LAYOUT AT ENTRANCE RAMP

GENERAL LAYOUT AT EXIT RAMP

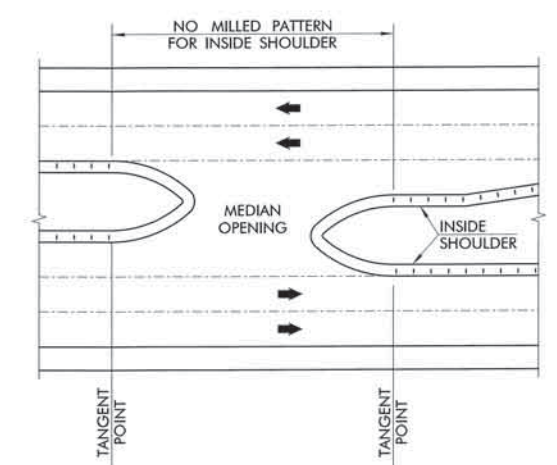

GENERAL LAYOUT INSIDE SHOULDERS AND MEDIAN OPENING

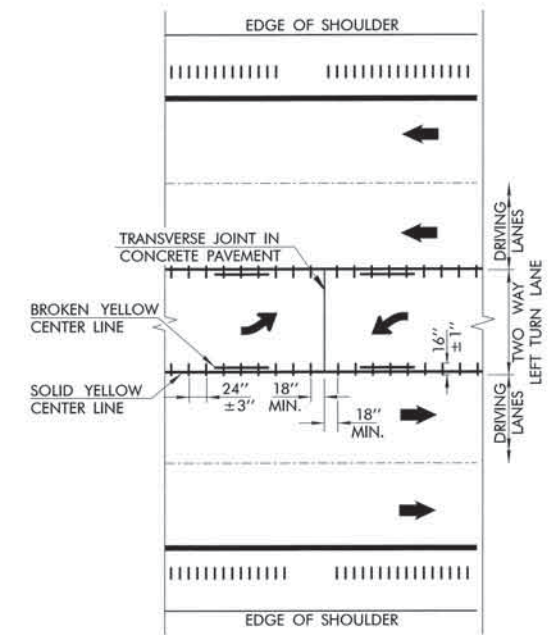

TYPICAL SPACING TWO WAY LEFT TURN LANES (TWLTL)

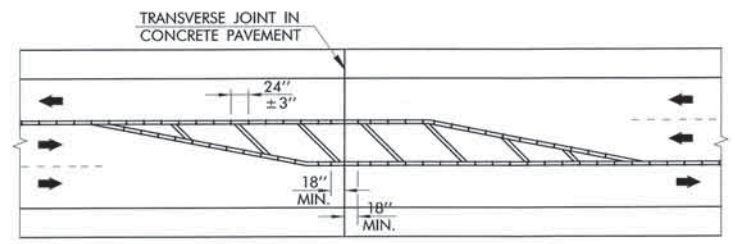

GENERAL LAYOUT FOR CENTERLINE RUMBLE STRIP AT SUPER TWO TRANSITION (TWO-WAY THREE LANE HIGHWAY)

GENERAL NOTES

1. ALL CONSTRUCTION AND MATERIAL REQUIREMENTS SHALL BE IN ACCORDANCE WITH THE 2009 ODOT STANDARD SPECIFICATIONS.
2. WHERE A DRIVEWAY INTERSECTS THE HIGHWAY, THE CENTERLINE RUMBLE STRIP SHALL NOT BE BROKEN. THERE COULD BE EXCEPTIONS TO THIS POLICY IF THE FIELD DIVISION ENGINEER, OR HIS/HER REPRESENTATIVE, DETERMINES THE DRIVEWAY TO BE A HEAVILY USED COMMERCIAL, INDUSTRIAL OR SUBDIVISION DRIVEWAY. IF AN EXCEPTION IS MADE, THE LOCATION AND EXTENT OF THE BREAK IS TO BE DETERMINED BY THE FIELD DIVISION ENGINEER OR HIS/HER REPRESENTATIVE.
3. APPLY PAVEMENT MARKINGS OVER THE CENTER LINE AND TWO WAY LEFT TURN LANE RUMBLE STRIP FOR NORMAL PAVEMENT MARKING SPACING.
4. PAYMENT FOR THIS PAY ITEM SHALL BE BASED ON THE TOTAL LINEAR FEET. GAPS, FOR EXAMPLE, ACROSS STREETS, OTHER HIGHWAYS, MEDIAN OPENINGS, RAMPS, AND TRANSVERSE JOINTS, SHALL BE EXCLUDED. THIS PAY ITEM IS TO BE USED FOR CENTERLINE, TWO WAY LEFT TURN LANES, AND INSIDE SHOULDER APPLICATIONS

BASIS OF PAYMENT		
ITEM NO.	ITEM	UNIT
413 (A)	RUMBLE STRIP - CENTERLINE HMA-CON	(4) L.F.
413 (C)	RUMBLE STRIP - CENTERLINE PCC-CON	(4) L.F.

APPROVED BY
TRAFFIC ENGINEER: *[Signature]* DATE: 7-14-16

DOT TRAFFIC STANDARD
CENTERLINE RUMBLE STRIP
(NON-INTERSTATE SYSTEM ONLY)

2009 SPECIFICATIONS

RS2-2	00
T-612	

81550471515

ALL GENERAL NOTES SHOWN BELOW SHALL APPLY TO ALL OF THE STANDARD DRAWINGS IN TCS SERIES

DESCRIPTION	REVISIONS	DATE
MODIFIED NOTES		3/15/2011

CONTRACTOR

ON CONSTRUCTION PROJECTS IT WILL BE THE CONTRACTORS RESPONSIBILITY TO INSTALL THE NECESSARY TRAFFIC CONTROL BEFORE CONSTRUCTION BEGINS.

THE CONTRACTOR SHALL BE RESPONSIBLE FOR MAINTAINING ALL DEVICES TO ASSURE A HIGH DEGREE OF BOTH DAY AND NIGHT VISIBILITY, WHICH WILL INCLUDE ANY WASHING, REPLACEMENT AND/OR REPOSITIONING WHERE DEEMED NECESSARY BY THE ENGINEER.

THE CONTRACTOR SHALL REPAIR OR REPLACE ANY NEW OR EXISTING PERMANENT STATE OWNED SIGNS WHICH ARE DAMAGED DUE TO HIS NEGLIGENCE OR CARELESS HANDLING DURING THE CONSTRUCTION OF THIS PROJECT. THIS SHALL BE DONE AT THE CONTRACTORS EXPENSE.

THE CONTRACTOR SHALL BE RESPONSIBLE FOR MAINTAINING TEMPORARY TRAFFIC CONTROL WORK ZONE AND EXISTING PAVEMENT MARKINGS ON ALL ROADWAYS OPEN TO TRAFFIC WITHIN THE PROJECT. SUFFICIENT QUANTITIES HAVE BEEN PROVIDED FOR MAINTAINING PAVEMENT MARKINGS FOR PRESCRIBED DETOUR ROUTES WHEN DEEMED NECESSARY BY THE ENGINEER.

SIGN MATERIALS

ALL SIGN BLANK MATERIALS SHALL BE THE OPTION OF THE CONTRACTOR BUT SHALL BE OF SUCH MATERIAL THAT WILL RETAIN A SATISFACTORY APPEARANCE THROUGHOUT THE LIFE OF THE PROJECT.

ALL SIGNS, LIGHTS, FLAGS, ETC. SHALL CONFORM IN SIZE, SHAPE, COLOR, LEGENDS AND APPLICATIONS TO THE STANDARDS SET FORTH IN THE MANUAL ON UNIFORM TRAFFIC CONTROL DEVICES AND/OR OKLAHOMA STATE STANDARD DRAWINGS FOR SIGNS. STANDARD DRAWINGS ARE AVAILABLE FROM THE DEPARTMENT OF TRANSPORTATION. INTERPRETATIONS THAT MAY BE NECESSARY SHALL BE REFERRED TO THE ENGINEER.

SIGN SHEETING

REFLECTORIZATION OF TRAFFIC CONTROL DEVICES SHALL BE BY MEANS OF WIDE ANGLE, FLAT TOP REFLECTIVE SHEETING MEETING THE REQUIREMENTS OF 2009, OKLAHOMA STANDARD SPECIFICATIONS.

SIGN INSTALLATION

ALL SIGNS SHALL BE SECURELY PLACED OR WEIGHTED TO PREVENT BLOWING OVER. ROCKS, BROKEN CONCRETE OR OTHER SUCH OBJECTS SHALL NOT BE CONSIDERED AN ACCEPTABLE SUBSTITUTE FOR SAND BAGS WHEN USED TO OBTAIN ADDED STABILITY FOR MOVABLE SIGNS AND BARRICADES.

SPACING OF SIGNING, ON THE PLANS OR TCS STANDARDS, SHOULD BE NO LESS THAN THE DISTANCES SHOWN. THE DISTANCE BETWEEN SIGNS SHOULD BE INCREASED ON HIGH SPEED OR MORE HEAVILY TRAVELED HIGHWAYS, OR WHERE SIGHT DISTANCE IS RESTRICTED.

IN ALL CONSTRUCTION ZONES, THE 48 INCH X 48 INCH WARNING SIGNS SHALL HAVE ATTACHED THERETO FLORESCENT FLAGS AND TYPE "A" WARNING LIGHTS. THIS SHALL ALSO APPLY WHEN SIGNS ARE USED ON BOTH SIDES OF THE ROADWAY. ADDITIONAL FLASHING LIGHTS MAY BE REQUIRED WHEN SO DESIRED BY THE ENGINEER.

ALL DIAMOND SHAPED CONSTRUCTION WARNING SIGNS ON EXPRESSWAYS OR FREEWAYS SHALL BE 48 INCH X 48 INCH, WITH THE APPROPRIATE ADVISORY SIGN WHERE REQUIRED UNLESS OTHERWISE NOTED IN THE PLANS.

DUE TO THE TEMPORARY NATURE OF CONSTRUCTION, SIGNS WHICH ARE 33 S.F. AND OVER WILL HAVE NO REINFORCING STEEL IN THEIR FOOTINGS.

ALL SIGNS AND SIGN ASSEMBLIES WITH A TOTAL SURFACE AREA OF 10 S.F. OR MORE SHALL BE INSTALLED ON TWO (2) POSTS. THE EXCEPTION BEING SINGLE ROUTE MARKER ASSEMBLIES.

SIGNS MOUNTED ON BARRICADES SHALL BE MOUNTED AS HIGH AS NECESSARY TO BE VISIBLE.

BARRICADES

ONE (1) WING BARRICADE SHALL BE SET ON EACH SIDE OF THE ROADWAY IN ADVANCE OF THE FIRST ADVANCE WARNING SIGN. THE EXCEPTIONS ARE MINOR CROSS STREETS AND SECTION LINE ROADS WHICH INTERSECT THE WORK AREA.

WING BARRICADES SHALL BE INSTALLED ON TWO (2) BREAKAWAY POSTS.

WORK DURATION

THE FIVE CATEGORIES OF WORK DURATION AND THEIR TIME AT A LOCATION SHALL BE:
 A) LONG-TERM STATIONARY IS WORK THAT OCCUPIES A LOCATION MORE THAN 3 DAYS.
 B) INTERMEDIATE-TERM STATIONARY IS WORK THAT OCCUPIES A LOCATION MORE THAN ONE DAYLIGHT PERIOD UP TO 3 DAYS, OR NIGHTTIME WORKLASTING MORE THAN 1 HOUR.
 C) SHORT-TERM STATIONARY IS DAYTIME WORK THAT OCCUPIES A LOCATION FOR MORE THAN 1 HOUR WITHIN A SINGLE DAYLIGHT PERIOD.
 D) SHORT DURATION IS WORK THAT OCCUPIES A LOCATION UP TO 1 HOUR.
 E) MOBILE IS WORK THAT MOVES INTERMITTENTLY OR CONTINUOUSLY.

LIGHTING

TYPE "A" WARNING LIGHTS SHALL BE USED ON BARRICADES (AS REQUIRED) AND WARNING SIGNS.

TYPE "C" WARNING LIGHTS MAY BE USED ON VERTICAL PANELS (OPTIONAL).

CONSTRUCTION NOTES

SHOULD THE REQUIRED WORK ON ANY PROJECT, INCLUDING ANY TRAFFIC CONTROL, OVERLAP OR OTHERWISE INTERFERE WITH THE ON-GOING WORK OR TRAFFIC CONTROL OF ANOTHER PROJECT, IT SHALL BE THE RESPONSIBILITY OF THE RESPECTIVE CONTRACTORS TO COORDINATE THEIR WORK ACTIVITIES TO FACILITATE THE SAFE MOVEMENT OF TRAFFIC THROUGHOUT OR AROUND THEIR COLLECTIVE WORK AREAS. ANY SUCH RECOMMENDED CHANGES SHALL BE SUBMITTED IN WRITING TO EACH PROJECT RESIDENT ENGINEER FOR REVIEW AND APPROVAL.

ALL TRAFFIC CONTROL DEVICES NOT REQUIRED FOR THE SAFE CONDUCT OF TRAFFIC THROUGH THE TEMPORARY TRAFFIC CONTROL ZONE SHALL BE PROMPTLY REMOVED, COMPLETELY COVERED, TURNED AWAY FROM TRAFFIC OR OTHERWISE TAKEN OUT OF SERVICE. DEVICES SHALL NOT BE STORED ALONG THE ROADWAY WITHIN 15 FEET (15') OF AN OPEN DRIVING LANE, EITHER BEFORE OR AFTER THEY ARE TO BE USED UNLESS PROTECTED BY GUARDRAIL, BRIDGE RAIL, AND/OR BARRIERS INSTALLED FOR OTHER PURPOSES. THESE DEVICES SHALL BE REMOVED FROM THE TEMPORARY TRAFFIC CONTROL ZONE WHEN THE ENGINEER DETERMINES THEY ARE NO LONGER NEEDED. WHERE THERE IS INSUFFICIENT RIGHT-OF-WAY TO PROVIDE FOR THIS 15 FEET (15') SETBACK, THE CONTRACTOR SHALL DETERMINE ALTERNATE LOCATIONS AND REQUEST THE ENGINEERS APPROVAL TO USE THEM.

TRAFFIC CONTROL DEVICES, WARNING DEVICES, AND BARRIERS SHALL BE KEPT IN CORRECT POSITION, PROPERLY DIRECTED, CLEARLY VISIBLE AND CLEAN AT ALL TIMES. DAMAGED, DEFACED OR DIRTY DEVICES OR BARRICADES SHALL IMMEDIATELY BE REPAIRED, REPLACED OR CLEANED BY THE CONTRACTOR AND APPROVED FOR USE BY THE ENGINEER.

NO EQUIPMENT OR VEHICLES BELONGING TO THE CONTRACTOR, HIS SUB-CONTRACTORS OR EMPLOYEES SHALL BE PARKED OR STOPPED WITHIN 30 FEET (30') OF A LANE CARRYING TRAFFIC, AT ANY TIME, UNLESS REQUIRED BY ONGOING WORK OPERATIONS.

ALL DETOURS AND DIVERSIONS SHOULD BE IN PLACE, WITH SIGNING, STRIPING AND CHANNELIZING DEVICES, AS SHOWN IN THE PLANS OR STANDARD DRAWINGS, BEFORE THEY ARE OPENED TO TRAFFIC.

WHEN IT BECOMES NECESSARY TO CLOSE THE ROAD TO THROUGH TRAFFIC, NO LESS THAN SEVEN DAYS PRIOR TO THE CLOSURE, THE CONTRACTOR SHALL NOTIFY THE FOLLOWING INDIVIDUALS OR AGENCIES DESCRIBING THE AFFECTED ROAD AND THE APPROXIMATE DURATION OF THE CLOSURE. THOSE TO BE NOTIFIED INCLUDE BUT ARE NOT LIMITED TO 1) LOCAL LAW ENFORCEMENT OFFICIALS, 2) LOCAL FIRE OFFICIALS, 3) AMBULANCE SERVICES, 4) LOCAL SCHOOL SUPERINTENDENT, 5) UNITED STATES POSTAL SERVICE, AND 6) CITY OR COUNTY ROAD SUPERINTENDENT.

ALL TEMPORARY TRAFFIC CONTROL DEVICES, AND THEIR CONDITIONS THROUGHOUT THE LIFE OF THE CONSTRUCTION PROJECT, SHALL MEET O.D.O.T.'S LATEST "QUALITY STANDARDS FOR TEMPORARY TRAFFIC CONTROL DEVICES". THE O.D.O.T. RESIDENT ENGINEER WILL MAKE FINAL DECISION OF ALL TEMPORARY TRAFFIC CONTROL DEVICES BASED ON THE O.D.O.T. GUIDELINES.

NO GENDER BIAS SIGNS ARE ALLOWED.

ARROW DISPLAY

USE OF AN ARROW DISPLAY, IN THE ARROW OR CHEVRON MODE, SHALL BE LIMITED TO STATIONARY OR MOVING LANE CLOSURES.

AN ARROW DISPLAY, IN THE CAUTION MODE, SHALL BE USED ONLY FOR SHOULDER WORK, BLOCKING THE SHOULDER, ROADSIDE WORK NEAR THE SHOULDER, OR FOR MOBILE OPERATIONS (I.E. STRIPING).

AN ARROW DISPLAY IN THE ARROW OR CHEVRON MODE, SHALL NOT BE USED ON A TWO-LANE, TWO-WAY ROADWAY FOR TEMPORARY ONE-LANE OPERATION.

AN ARROW DISPLAY SHALL NOT BE USED ON A MULTI-LANE ROADWAY TO LATERALLY SHIFT TRAFFIC.

CHANNELIZING DEVICES

IN THOSE AREAS WHERE DRIVERS ARE ASKED TO MAKE A DECISION OR MUST BE GUIDED THROUGH A PRECISE MOVEMENT, BY USE OF CHANNELIZING DEVICES, IT IS ESPECIALLY IMPORTANT TO PROVIDE A CLEARLY DEFINED PATH. EXAMPLES OF THIS COULD BE IN DELINEATING A TEMPORARY GORE OR TURNING RADIUS. IN SUCH AREAS THE SPACING OF CHANNELIZING DEVICES MAY BE REDUCED TO 10 FEET FOR SPEEDS OF 40 M.P.H. OR LESS, AND 20 FEET FOR SPEEDS GREATER THAN 40 M.P.H.

WHEN CHANNELIZING DEVICES ARE USED TO DIRECT TRAFFIC ACROSS EXISTING LANE LINES OR EDGE LINES, THE SPACING BETWEEN CHANNELIZING DEVICES SHALL BE REDUCED 50%. SPACING SHOULD ALSO BE REDUCED WHEN CHANNELIZING DEVICES ARE PLACED ON CURVES, HILLS, OR NEXT TO POTENTIAL HAZARDS.

ALL TRAFFIC CONTROL CHANNELIZING DEVICES SHALL MEET MUTCD COLOR REQUIREMENTS.

FLAGGERS

FLAGGERS MUST BE CLEARLY VISIBLE TO APPROACHING TRAFFIC FOR A DISTANCE SUFFICIENT TO PERMIT PROPER RESPONSE BY MOTORISTS TO THE FLAGGING INSTRUCTIONS, AND TO PERMIT TRAFFIC TO REDUCE SPEED OR STOP BEFORE ENTERING THE TEMPORARY TRAFFIC CONTROL ZONE. FLAGGERS SHALL BE POSITIONED TO MAINTAIN MAXIMUM COLOR CONTRAST BETWEEN THE FLAGGER'S REFLECTIVE CLOTHING AND EQUIPMENT AND THE WORK AREA BACKGROUND.

DURING HOURS OF DARKNESS, FLAGGER STATIONS SHALL BE ILLUMINATED SUCH THAT THE FLAGGER WILL BE CLEARLY VISIBLE TO APPROACHING TRAFFIC. LIGHTS TO BE USED FOR ILLUMINATING THE STATION SHALL BE APPROVED BY THE ENGINEER. REFLECTORIZED PADDLES AND REFLECTORIZED VESTS, SHIRTS OR JACKETS SHALL BE USED FOR NIGHTTIME FLAGGING.

UNLESS OTHERWISE SPECIFIED IN THE PLANS, THE COST OF FLAGGING OPERATIONS SHALL BE INCLUDED IN OTHER ITEMS OF WORK.

MINIMUM STANDARDS FOR TRAFFIC CONTROL DEVICES

- (1) WARNING LIGHTS (TYPE A FLASHERS AND TYPE C STEADY BURN)
 - (A) NOT LESS THAN NINETY (90) PERCENT OF THE TOTAL NUMBER OF LIGHTS BEING USED AT ANY ONE TIME SHALL BE FULLY OPERATIONAL.
 - (B) NOT MORE THAN THREE (3) LIGHTS ADJACENT TO ONE ANOTHER SHALL BE FAILING.
- (2) ARROW DISPLAY
 - (A) WHEN IN ARROW MODE, NO MORE THAN TWO (2) LAMPS IN THE STEM AND ZERO (0) LAMPS IN THE HEAD SHALL BE FAILING. THE DIMMING FUNCTION SHALL BE OPERATING PROPERLY.
 - (B) WHEN IN CAUTION MODE (CORNERS), A MINIMUM OF FOUR (4) LAMPS SHALL BE OPERATIONAL. THE DIMMING FUNCTION SHALL BE OPERATING PROPERLY.
 - (C) ANY LAMP WHICH IS LIGHTED BUT IMPROPERLY ALIGNED SHALL NOT BE CONSIDERED OPERATIONAL.
- (3) CHANGEABLE MESSAGE SIGNS
 - (A) NOT LESS THAN NINETY (90) PERCENT OF THE PIXELS SHALL BE FUNCTIONAL IN EACH CHARACTER MODULE.
 - (B) NO SANDBAG BALLASTING OVER 3 FEET IN HEIGHT.
- (4) PAVEMENT MARKING TAPE
 - (A) NOT MORE THAN TEN (10) PERCENT OF ALL TAPE, PAINT, MESSAGE OR SYMBOL SHALL BE MISSING.
 - (B) NOT MORE THAN TWO (2) CONSECUTIVE DASHED LINES SHALL BE MISSING.
 - (C) NOT MORE THAN FIFTY (50) CONTINUOUS FEET OF A SOLID LINE SHALL BE MISSING.
- (5) CONSTRUCTION ZONE PAVEMENT MARKERS
 - (A) NOT MORE THAN TEN (10) PERCENT OF THE TOTAL NUMBER OF MARKERS SHALL BE MISSING.
 - (B) NOT MORE THAN THREE (3) CONSECUTIVE MARKERS SHALL BE MISSING.

STRIPING

WHENEVER THE WORK CAUSES THE OBLITERATION OF PAVEMENT MARKINGS, EITHER TEMPORARY OR PERMANENT MARKINGS SHALL BE IN PLACE PRIOR TO OPENING THE ROADWAY TO TRAFFIC. CENTERLINE PAVEMENT MARKINGS SHALL BE PROVIDED AT ALL TIMES FOR ROADWAYS OPEN TO TRAFFIC.

THE APPLICATION SURFACES FOR PAVEMENT MARKINGS SHALL BE FREE OF DUST, DIRT, MOISTURE OR OTHER FOREIGN MATTER WHICH WOULD INTERFERE WITH ADHESION. INSTALLATION OF ALL PAVEMENT MARKINGS SHALL BE IN ACCORDANCE WITH THE MANUFACTURERS RECOMMENDATIONS.

ALL TEMPORARY PAVEMENT MARKINGS SHALL BE REMOVED IMMEDIATELY AHEAD OF THE PERMANENT STRIPING OPERATIONS OR RE-STRIPING FOR FOLLOWING CONSTRUCTION PHASES.

WHEN REMOVABLE PAVEMENT MARKINGS TAPE IS TO BE INSTALLED ON NEW CONCRETE PAVEMENT, THE CURING COMPOUND SHALL BE REMOVED PRIOR TO INSTALLATION.

IF REMOVABLE PAVEMENT MARKING TAPE IS INSTALLED IN ACCORDANCE WITH THE MANUFACTURERS SPECIFICATIONS AND FAILS DURING THE FIRST SIX MONTHS OF SERVICE, IT SHALL BE REPLACED AT THE CONTRACTOR'S EXPENSE. REPLACEMENT SHALL BE ACCOMPLISHED IN A TIMELY MANNER UPON BEING NOTIFIED, BY THE ENGINEER, OF SUCH FAILURE.

PILOT CAR

WHEN LANE CLOSURES ARE REQUIRED ON TWO-LANE /TWO-WAY ROADWAYS, THE CONTRACTOR MAY, AT HIS OPTION, UTILIZE A PILOT CAR. IF THE CONTRACTOR ELECTS TO USE A PILOT CAR, CHANNELIZING DEVICES ALONG THE CENTERLINE WILL NOT BE REQUIRED. THE PILOT CAR OPERATOR SHALL BE IN RADIO CONTACT WITH PERSONNEL IN THE TEMPORARY TRAFFIC CONTROL ZONE. MAXIMUM SPEED OF THE PILOT CAR THROUGH THE WORK AREA SHALL BE 25 M.P.H. FULL COMPENSATION FOR FURNISHING AND OPERATING THE PILOT CAR, (INCLUDING DRIVER, RADIOS, AND ANY OTHER EQUIPMENT OR LABOR REQUIRED) SHALL BE CONSIDERED AS INCLUDED IN THE COST OF OTHER ITEMS OF WORK.

MISCELLANEOUS

TRAFFIC CONDITIONS MAY NECESSITATE CHANGES IN THE USE AND/OR QUANTITIES OF THE TRAFFIC CONTROL DEVICES AS SHOWN IN THE PLANS OR IN THE STANDARDS. ANY SUCH CHANGES ARE SUBJECT TO APPROVAL BY THE ENGINEER.

ALL CHANNELIZING DEVICES PROVIDED ON THIS PROJECT SHALL BE IN GOOD CONDITION AND SHALL BE APPROVED FOR USE ON THIS PROJECT BY THE ENGINEER.

THE REGULATORY SPEED LIMITS THROUGH THE WORK ZONE MAY BE ADJUSTED AT THE DISCRETION OF THE ENGINEER WITH THE DOCUMENTED APPROVAL OF THE DIVISION ENGINEER IN ACCORDANCE WITH TITLE 47 OF THE OKLAHOMA MOTOR VEHICLE LAWS.

THE TERMINATION AREA EXTENDS FROM THE DOWNSTREAM END OF THE WORK AREA TO THE TEMPORARY TRAFFIC CONTROL DEVICE SUCH AS "END ROAD WORK" SIGNS. IF POSTED, A SPEED SIGN, OR OTHER SIGNS MAY BE USED TO INFORM ROAD USERS THAT THEY CAN RESUME NORMAL OPERATIONS.

THE CONSTRUCTION SIGNING AND BARRICADE CONTRACTOR SHOULD AFFIX THEIR COMPANY NAME AND/OR LOGO INCONSPICUOUSLY ON EACH TRAFFIC CONTROL DEVICE.



APPROVED BY TRAFFIC ENGINEER: *Shelby Gray* DATE: 3/21/11

TRAFFIC STANDARD
 TRAFFIC CONTROL STANDARD
 TRAFFIC CONTROL CONSTRUCTION NOTES

2009 SPECIFICATIONS

TCS1-1	01
T-501	

\$\$\$date\$\$\$

TAPER LENGTH CRITERIA FOR WORK ZONES

SPEED LIMIT M.P.H.	W* FORMULA	TAPER LENGTH (MINIMUM) (FT)			NUMBER OF CHANNELIZING DEVICES REQUIRED (MINIMUM)			SPACING CHANNELIZING DEVICES (MAXIMUM)		MAXIMUM HORIZONTAL ALIGNMENT THRU DETOUR (S=0)	SPEED LIMIT M.P.H.
		10' OFFSET	11' OFFSET	12' OFFSET	10' OFFSET	11' OFFSET	12' OFFSET	① THRU TAPER SECTION (FT.)	② THRU TANGENT SECTION (FT.)		
20	$L = \frac{W \times S^2}{60}$	70	75	80	5	5	5	20	40	—	20
25		105	115	125	6	6	6	25	50	—	25
30		150	165	180	6	7	7	30	60	15	30
35		205	225	245	7	8	8	35	70	11	35
40	$L = W \times S$	265	295	320	8	9	9	40	80	8	40
45		450	495	540	11	12	13	45	90	6	45
50		500	550	600	11	12	13	50	100	5	50
55		550	605	660	12	14	15	50	100	4	55
60		600	660	720	13	15	16	50	100	3	60
65		650	715	780	14	16	17	50	100	2.5	65
70		700	770	840	15	17	18	50	100	2	70
75	750	825	900	16	18	19	50	100	1.8	75	

NOTES:

① RECOMMENDED SIGNING TO BE USED THRU LANE TAPER IS (1) CW-8 ON EVERY OTHER DRUM.

② RECOMMENDED SIGNING TO BE USED THRU TANGENT LANES IS (1) R4-7A(R) OR (1) R4-7A(L) (AS APPLIES) ON EVERY OTHER DRUM.

L = TAPER LENGTH IN FEET
W = WIDTH OF OFFSET IN FEET
S = POSTED SPEED OR OFF-PEAK 85 PERCENTILE SPEED IN MPH

TYPE OF TAPER
UPSTREAM TAPERS
MERGING TAPER
SHIFTING TAPER
SHOULDER TAPER
TWO-WAY TRAFFIC TAPER

TAPER LENGTH
L MINIMUM
1/2 L MINIMUM
1/3 L MINIMUM
100 FEET MAXIMUM

DOWNSTREAM TAPERS
(USE IS OPTIONAL)
100 FEET PER LANE

FLARE RATES FOR CONCRETE MEDIAN BARRIER IN TEMPORARY TRAFFIC CONTROL ZONES

SPEED *	FLARE RATE (MINIMUM)
40 M.P.H.	9 TO 1
45 M.P.H.	10 TO 1
50 M.P.H.	11 TO 1
55 M.P.H.	12 TO 1
60 M.P.H.	13 TO 1
65 M.P.H.	14 TO 1
70 M.P.H.	15 TO 1
75 M.P.H.	16 TO 1

* POSTED SPEED LIMIT PRIOR TO CONSTRUCTION

STOPPING SIGHT DISTANCE AS A FUNCTION OF SPEED

SPEED * (MPH)	LENGTH (FEET)
20 M.P.H.	115
25 M.P.H.	155
30 M.P.H.	200
35 M.P.H.	250
40 M.P.H.	305
45 M.P.H.	360
50 M.P.H.	425
55 M.P.H.	495
60 M.P.H.	570
65 M.P.H.	645
70 M.P.H.	730
75 M.P.H.	820

* POSTED SPEED, OFF-PEAK 85th PERCENTILE SPEED PRIOR TO WORK STARTING, OR THE ANTICIPATED OPERATING SPEED.

RECOMMENDED DISTANCE BETWEEN SIGNS (MIN.)			
ROAD TYPE	A (FT)	B (FT)	C (FT)
URBAN (LOW SPEED)	100	100	100
URBAN (HIGH SPEED)	350	350	350
RURAL	500	500	500
EXPRESSWAY / FREEWAY	1,000	1,500	2,640

PAVEMENT MARKINGS THROUGH TEMPORARY TRAFFIC CONTROL ZONE

		DRIVING SURFACE	FLEX TAB MARKERS	TAPE (REMOVABLE)	TAPE (NON-REMOVABLE)	PAINT	CONSTRUCTION ZONE PAVEMENT MARKERS
ASPHALT	EXISTING PAVEMENT TO BE REMOVED OR OVERLAYED IN THE NEXT PHASE		X	X	X	X	X
	EXISTING PAVEMENT TO BE LEFT IN PLACE THRU THE NEXT PHASE		X	X			X
	INTERMEDIATE LIFT		X	X	X	X	X
	MILLED SURFACE		X	X	X	X	X
	FINAL LIFT		X	X			
CONCRETE	EXISTING PAVEMENT TO BE REMOVED OR OVERLAYED IN THE NEXT PHASE		X	X	X	X	X
	EXISTING PAVEMENT TO BE LEFT IN PLACE THRU THE NEXT PHASE		X	X			X
	FINAL SURFACE		X	X		X	X

NOTE:
USE OF NON-REMOVABLE TAPE (FOILBACK) SHALL BE LIMITED TO THOSE CONDITIONS SHOWN IN THE TABLE.

RECOMMENDED CLEAR ZONE DISTANCE (FT) (CONSTRUCTION WORK ZONES)

DESIGN SPEED	DESIGN ADT	FILL SLOPES			CUT SLOPES		
		6:1 OR FLATTER	5:1 OR 4:1	3:1	3:1	4:1 OR 5:1	6:1 OR FLATTER
40 MPH OR LESS	UNDER 750	4	4	SEE NOTE 3	4	4	4
	750-1500	5	6		5	5	5
	1500-6000	6	7		6	6	6
	OVER 6000	7	8		7	7	7
45-50 MPH	UNDER 750	5	6		4	4	5
	750-1500	7	8		5	6	7
	1500-6000	8	10		6	7	8
	OVER 6000	10	12		7	9	10
55 MPH	UNDER 750	6	7		4	5	5
	750-1500	8	10		5	7	8
	1500-6000	10	12		7	8	10
	OVER 6000	11	13		8	10	11
60 MPH	UNDER 750	8	10	5	6	7	
	750-1500	10	13	6	8	10	
	1500-6000	13	16 *	7	9	12	
	OVER 6000	15	18 *	10	12	13	
65-70 MPH	UNDER 750	9	10	5	7	7	
	750-1500	12	14	6	9	10	
	1500-6000	14	17 *	8	11	13	
	OVER 6000	15	19 *	11	13	14	

NOTES:

* THE CLEAR ZONE MAY BE LIMITED TO 15 FEET FOR PRACTICALITY AND TO PROVIDE A CONSISTENT ROADWAY TEMPLATE.

(1) ALL DISTANCES ARE MEASURED FROM EDGE OF THE TRAVEL LANE.

(2) FOR CLEAR ZONES, THE "DESIGN ADT" WILL BE THE TOTAL ADT ON TWO-WAY ROADWAYS AND DIRECTIONAL ADT ON ONE-WAY ROADWAYS (E.G., RAMPS AND ONE ROADWAY OF A DIVIDED HIGHWAY).

(3) FILL SLOPES WHICH ARE 3:1 OR STEEPER ARE CRITICAL AND MAY REQUIRE A BARRIER. THEREFORE THERE IS NOT A CLEAR ZONE APPLICATION.

CROSSOVER CRITERIA FOR WORK ZONES

WIDTH OF MEDIAN (W) (FT)	LATERAL SHIFT - (P) (FT)	LENGTH OF CROSSOVER - LC * (FT)											
		V.	30 M.P.H.	35 M.P.H.	40 M.P.H.	45 M.P.H.	50 M.P.H.	55 M.P.H.	60 M.P.H.	65 M.P.H.	70 M.P.H.	75 M.P.H.	
		D.	15°	11°	8°	6°	5°	4°	3°	2.5°	2°	1.8°	
20	32	R.	382	521	716	955	1146	1433	1910	2292	2855	3183	
30	42		219	256	301	348	382	427	493	541	605	637	
40	52		250	293	344	398	437	489	565	619	692	730	
50	62		277	325	382	443	485	543	628	688	770	812	
60	72		301	354	417	483	529	593	685	751	841	886	
70	82		324	381	448	519	570	638	738	809	905	955	
80	92		344	405	478	554	608	681	787	863	966	1,018	
90	102		363	428	505	586	643	720	833	914	1,023	1,078	
100	112		381	450	531	616	676	758	877	962	1,076	1,135	
110	122		398	470	555	644	708	793	918	1,007	1,127	1,189	
120	132		414	489	578	672	738	827	958	1,050	1,176	1,240	
			429	508	601	698	767	860	995	1,092	1,223	1,290	

* CROSSOVER = REVERSE CURVE CONNECTION TYING TWO (2) PARALLEL ROADWAYS.



APPROVED BY
TRAFFIC ENGINEER *David Smart* DATE 6/23/10

TRAFFIC STANDARD
TRAFFIC CONTROL STANDARD
TRAFFIC CONTROL TABLES AND CHARTS

DESCRIPTION	REVISIONS	DATE
CHANGED TRANSITION NOTATION		5/31/2011

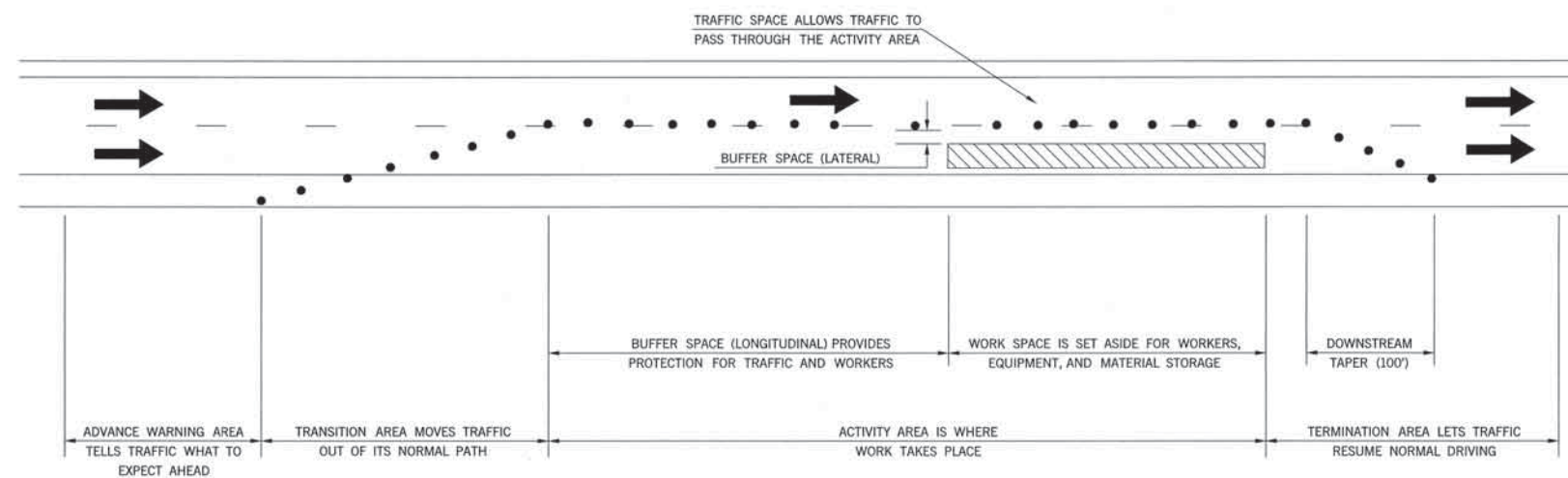

COMPONENT PARTS OF A TEMPORARY TRAFFIC CONTROL ZONE

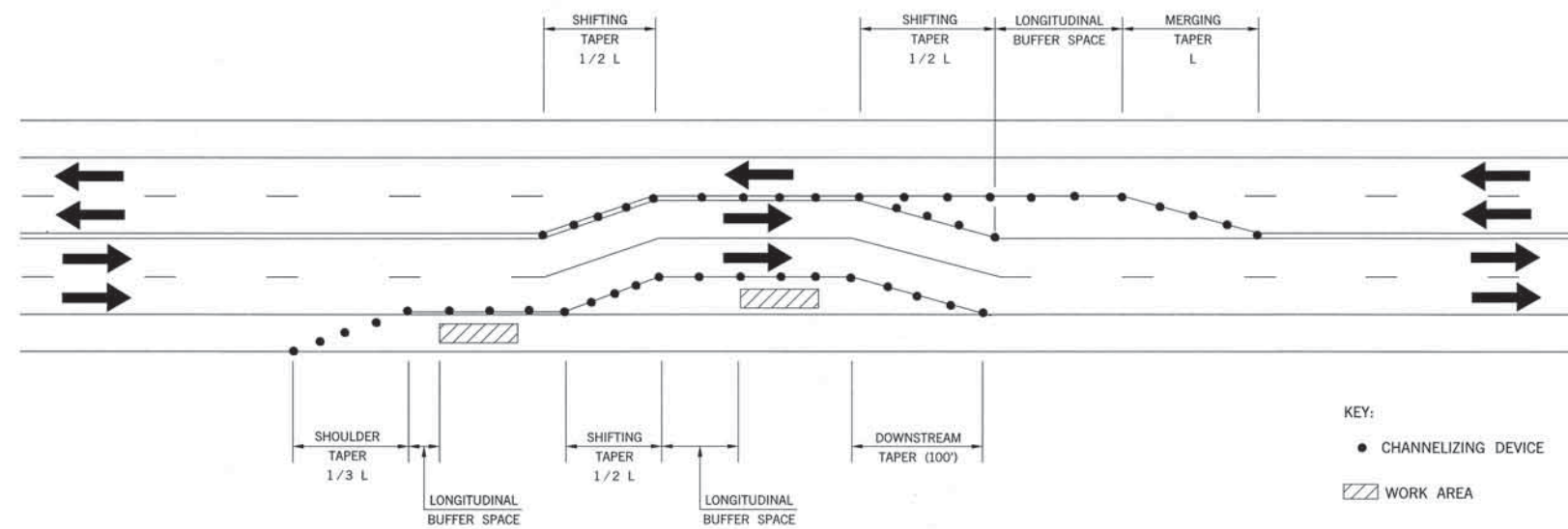

TAPERS AND BUFFER SPACE

TEMPORARY TRAFFIC CONTROL ELEMENTS



APPROVED BY TRAFFIC ENGINEER: *David G. Smith* DATE: 5/31/2011

TRAFFIC STANDARD
TRAFFIC CONTROL STANDARD
TEMPORARY TRAFFIC CONTROL ELEMENTS

2009 SPECIFICATIONS

TCS3-1 01
T-503

\$\$\$date\$\$\$

DESCRIPTION	REVISIONS	DATE
CHANGED TYPE 'C' LIGHT TO OPTIONAL		3/15/2011

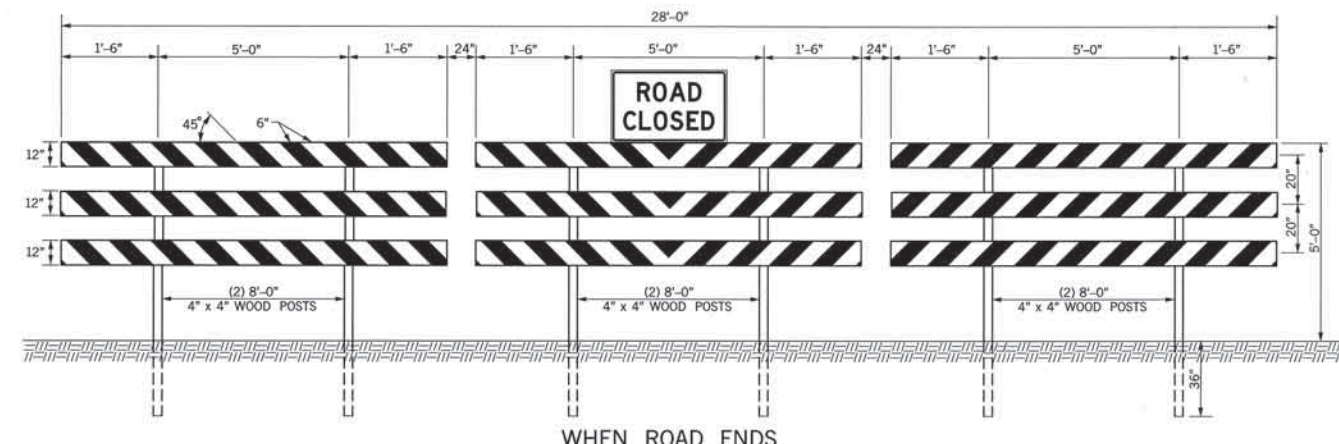

WHEN ROAD ENDS

PERMANENT TYPE III(A/B) BARRICADE
(DIMENSIONS ARE TYPICAL FOR BOTH BARRICADES)

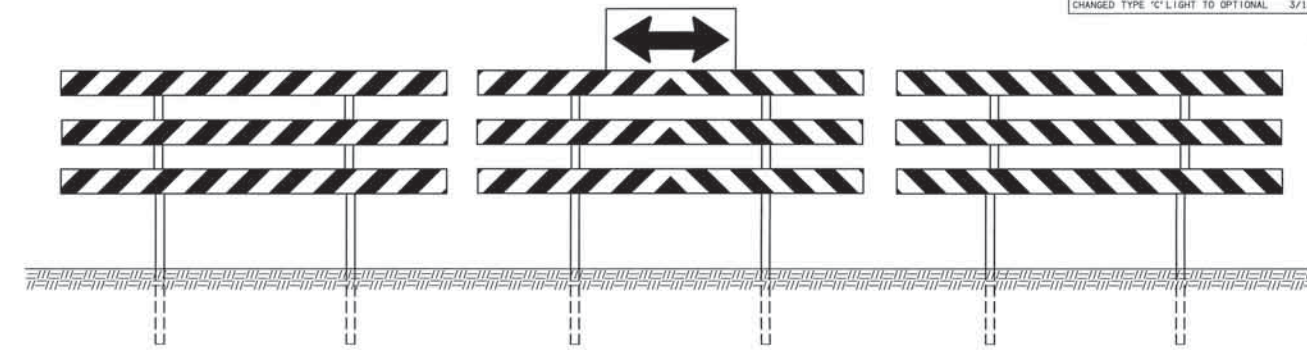

FOR T-INTERSECTIONS

NOTES: A PERMANENT BARRICADE TYPE III(A) SHALL CONSIST OF NINE (9) PANELS AND SIX (6) POSTS.
TYPICAL INSTALLATION AS SHOWN IS FOR AN ABSOLUTE CLOSURE.
BARRICADES SHOULD NOT BE PLACED PARALLEL TO TRAFFIC IF NOT OUTSIDE OF CLEAR ZONE.

PERMANENT BARRICADE TYPE III(B) WILL BE IDENTICAL TO TYPE III(A) WITH NINE (9) ADDITIONAL REFLECTORIZED 3/4"x12" LUMBER PANELS ATTACHED TO THE BACK SIDE OF THE BARRICADE.
COLOR: BACKGROUND - WHITE (REFLECTORIZED)
DIAGONAL STRIPES - RED (REFLECTORIZED)

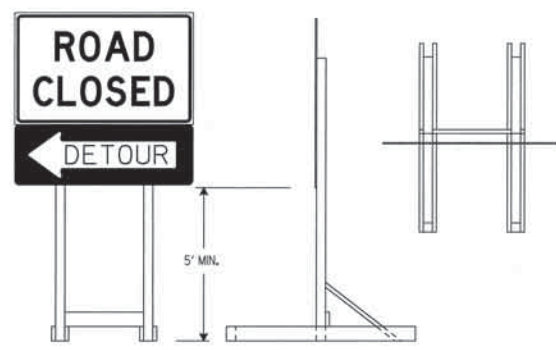

Skid-Mounted Sign Support with plywood sign

LONG INTERMEDIATE TERM STATIONARY PORTABLE SIGN SUPPORTS
5 Foot Mounting Height
(SKID MOUNTED)
(SHALL BE PLACED BEHIND TYPE III BARRICADE)

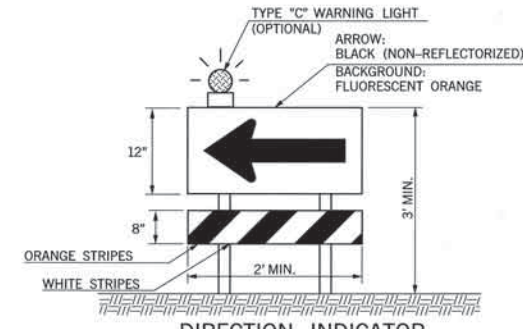

DIRECTION INDICATOR BARRICADE

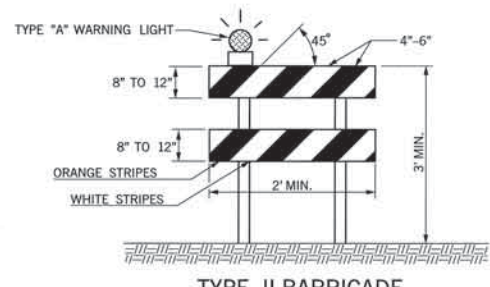

TYPE II BARRICADE

NOTES: FOR WOODEN BARRICADES NOMINAL LUMBER DIMENSIONS WILL BE SATISFACTORY.
FOR RAILS LESS THAN 3 FEET LONG, 4 INCH WIDE STRIPES SHALL BE USED.
TYPE III BARRICADES SHALL BE CONSTRUCTED USING A MINIMUM OF TWO (2) POSTS.
FOR WOODEN BARRICADES, PANEL THICKNESS SHALL NOT EXCEED ONE-HALF INCH (1/2").
BARRICADES SHOULD NOT BE PLACED PARALLEL TO TRAFFIC IF NOT OUTSIDE OF CLEAR ZONE.

PROJECTS WITH WORK LIMITS OF 2.0 MILES OR MORE IN LENGTH WILL REQUIRE THE G20-1A SIGN. THE SIGN (G20-1A) WILL BE REQUIRED ON ONE SIDE OF A 2-LANE ROADWAY AND BOTH SIDES OF A DIVIDED HIGHWAY.

ALL BARRICADE STRIPES SHALL BE RETROREFLECTIVE.
COLOR: BACKGROUND - WHITE (REFLECTORIZED)
DIAGONAL STRIPES - FLUORESCENT ORANGE (REFLECTORIZED)

IF BARRICADES ARE USED TO CHANNELIZE PEDESTRIANS, THERE SHALL BE CONTINUOUS DETECTABLE BOTTOM AND TOP RAILS WITH NO GAPS BETWEEN INDIVIDUAL BARRICADES TO BE DETECTABLE TO USERS OF LONG CANES. THE BOTTOM OF THE BOTTOM RAIL SHALL BE NO HIGHER THAN 6 INCHES ABOVE THE GROUND SURFACE. THE TOP OF THE TOP RAIL SHALL BE NO LOWER THAN 36 INCHES ABOVE THE GROUND SURFACE.

SIGNS MOUNTED ON TYPE III BARRICADES SHOULD NOT COVER MORE THAN 50 PERCENT OF THE TOP TWO RAILS OR 33 PERCENT OF THE TOTAL AREA OF THE THREE RAILS

SIGNS MOUNTED ON BARRICADES, OR OTHER PORTABLE SUPPORTS, SHALL BE NO LESS THAN 1' ABOVE THE TRAVELED WAY.

SANDBAGS MAY BE PLACED ON LOWER PARTS OF THE FRAME OR THE STAYS OF BARRICADES TO PROVIDE THE REQUIRED BALLAST.

BALLAST SHALL NOT BE PLACED ON TOP OF ANY STRIPED RAIL. BARRICADES SHALL NOT BE BALLASTED BY NONDEFORMABLE OBJECTS SUCH AS ROCKS OR CHUNKS OF CONCRETE. BALLAST SHALL NOT EXTEND INTO THE ACCESSIBLE PASSAGE WIDTH OF 60".

DIRECTION INDICATOR BARRICADE SHALL CONSIST OF A ONE-DIRECTION LARGE ARROW (W1-6) SIGN MOUNTED ABOVE A DIAGONAL STRIPED, HORIZONTALLY ALIGNED, RETROREFLECTIVE RAIL.

WHERE BARRICADES EXTEND ENTIRELY ACROSS A ROADWAY, THE STRIPES SHOULD SLOPE DOWNWARD IN THE DIRECTION TOWARD WHICH ROAD USERS MUST TURN.

WHERE BOTH RIGHT AND LEFT TURNS ARE PROVIDED, THE BARRICADE STRIPES SHOULD SLOPE DOWNWARD IN BOTH DIRECTIONS FROM THE CENTER OF THE BARRICADE OR BARRICADES.

WHERE NO TURNS ARE INTENDED, THE STRIPES SHOULD BE POSITIONED TO SLOPE DOWNWARD TOWARD THE CENTER OF THE BARRICADE OR BARRICADES.

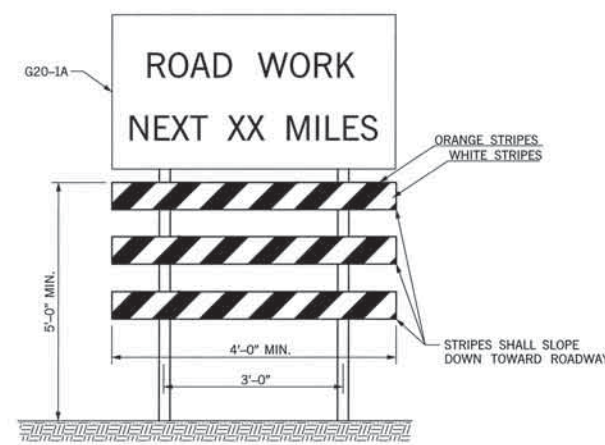

WING BARRICADE

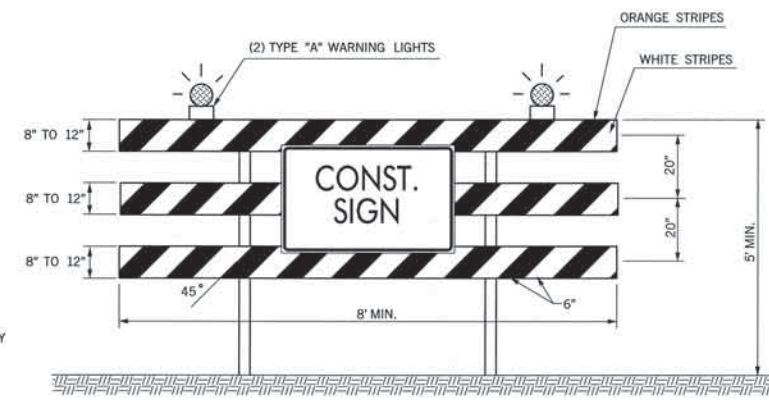

TYPE III BARRICADE

BASIS OF PAYMENT		
ITEM NO.	ITEM	UNIT
880(B)	CONSTRUCTION SIGNS	SD
880(C)	CONSTRUCTION BARRICADES	SD
880(E)	WARNING LIGHTS	SD

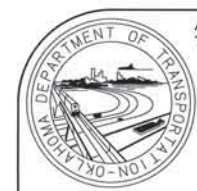

APPROVED BY TRAFFIC ENGINEER: *[Signature]* DATE: 3/21/11

TRAFFIC STANDARD
TRAFFIC CONTROL STANDARD
TRAFFIC CONTROL DEVICES

2009 SPECIFICATIONS

TCS4-1	01
T-504	

\$\$\$date\$\$\$

DESCRIPTION	REVISIONS	DATE

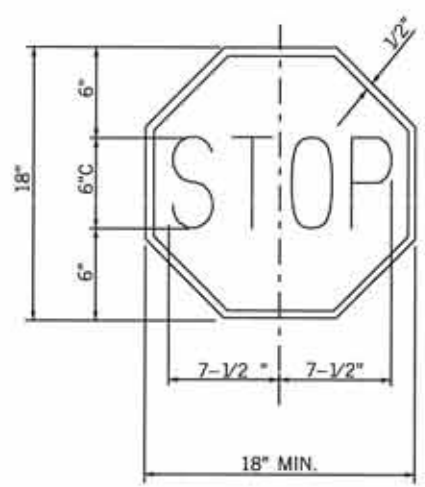

STOP:
LEGEND AND BORDER: WHITE (REFLECTORIZED)
BACKGROUND: RED (REFLECTORIZED)

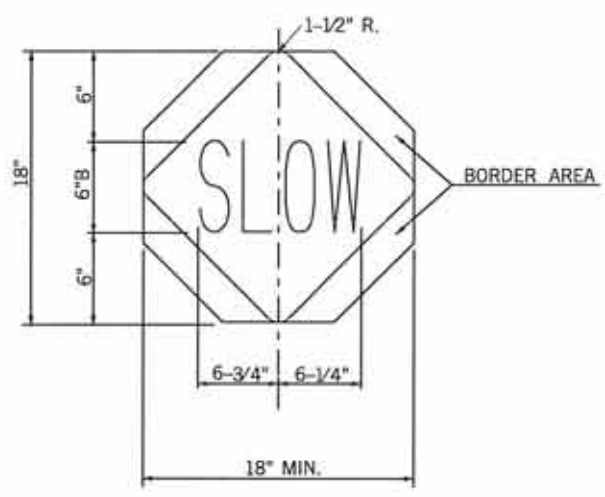

SLOW:
LEGEND AND BORDER AREA: BLACK (NON-REFLECTORIZED)
BACKGROUND: ORANGE (REFLECTORIZED)

STOP-SLOW PADDLE

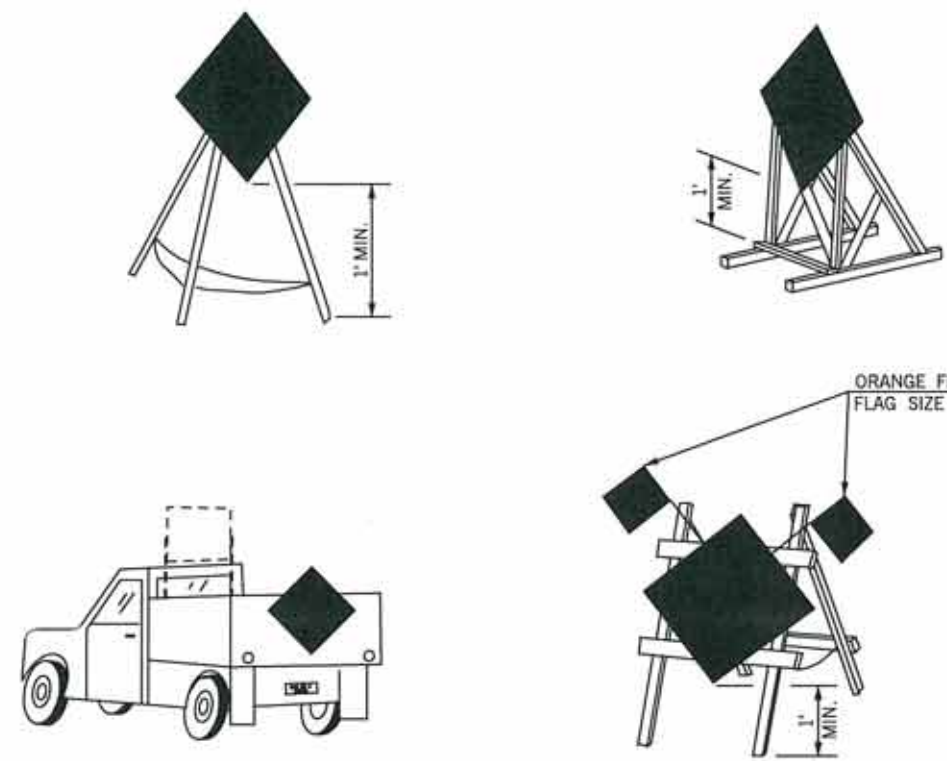

NOTE:
THE BOTTOM OF SIGNS MOUNTED ON BARRICADES OR TEMPORARY SUPPORTS SHALL NOT BE LESS THAN 1 FOOT ABOVE THE TRAVELED WAY.

PORTABLE AND TEMPORARY MOUNTINGS
METHODS OF MOUNTING SIGNS OTHER THAN ON POSTS



URBAN DISTRICT
(WITH CURB)

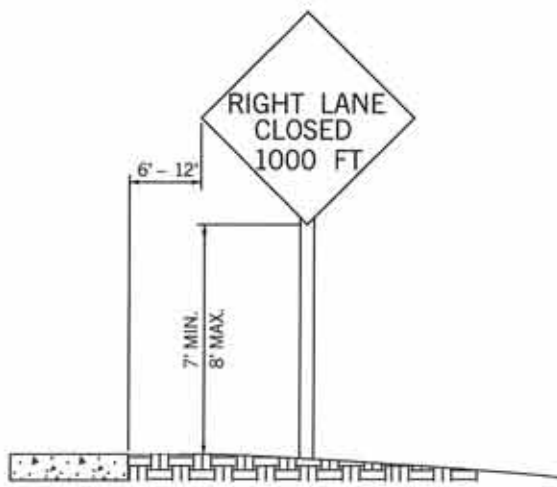

URBAN DISTRICT
(WITHOUT CURB)

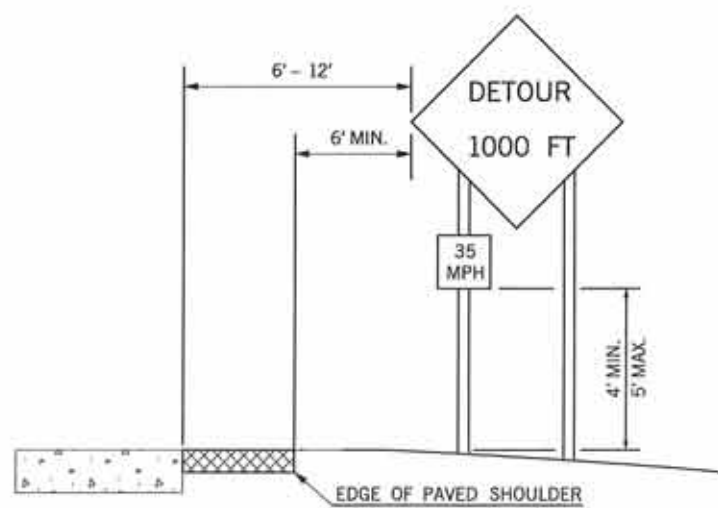

RURAL DISTRICT WITH
ADVISORY SPEED PLATE



RURAL DISTRICT

HEIGHT AND LATERAL LOCATIONS OF SIGNS - TYPICAL INSTALLATIONS



APPROVED BY
TRAFFIC ENGINEER: *Cheryl Smith* DATE: 6/23/10
TRAFFIC STANDARD

TRAFFIC CONTROL STANDARD
TYPICAL SIGN INSTALLATION

TRFPC36 M:\2009_Standards_TC\505.dgn 8:16:51 AM 6/2/2010 d:\usr2\flib\leroyh.psn R:\TRAF_FLOT\bw.tbl

DESCRIPTION	REVISIONS	DATE
ADD NOTE TO VERTICAL PANEL		07/19/10
CHANGED TYPE "C" LIGHT TO OPTIONAL		3/15/2011

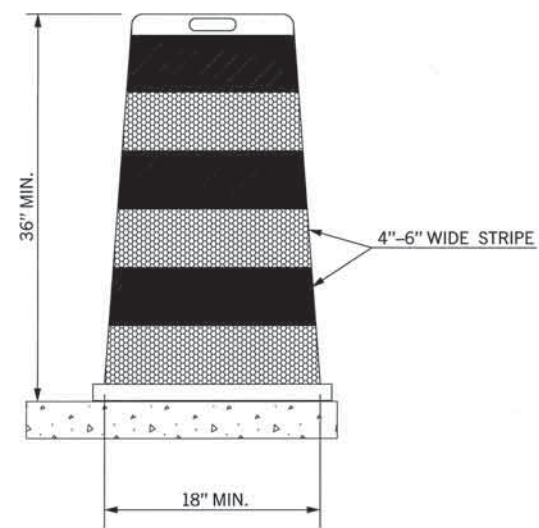

DRUM

NOTES:

METAL DRUMS SHALL NOT BE USED.
 EACH DRUM SHALL HAVE A MINIMUM OF TWO (2) FLUORESCENT ORANGE STRIPES ALTERNATING WITH A MINIMUM OF TWO (2) WHITE STRIPES. THESE STRIPES SHALL CONSIST OF RETROREFLECTIVE SHEETING.
 BALLAST SHALL NOT BE PLACED ON TOP OF A DRUM.
 DRUMS SHALL NOT BE USED TO DELINEATE AN EDGE DROP OFF IF THEY MUST BE PLACED IN THE DROP OFF AREA BELOW THE LEVEL OF THE DRIVING SURFACE.

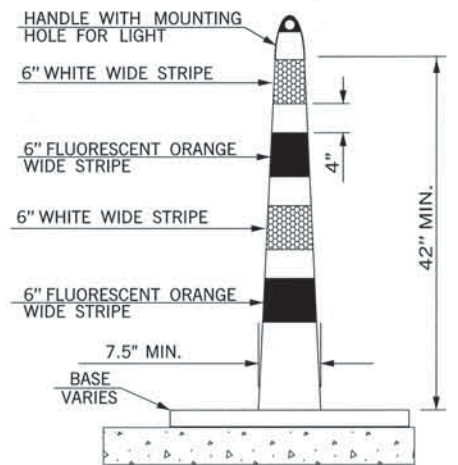

CHANNELIZER CONE

NOTES:

CHANNELIZER CONES USED ON HIGH SPEED ROADWAYS, ON ALL HIGHWAYS DURING NIGHTTIME, OR WHENEVER MORE CONSPICUOUS GUIDANCE IS NEEDED SHALL BE A MINIMUM OF 42 INCHES HIGH.
 EACH CHANNELIZER CONES SHALL HAVE A MINIMUM OF TWO (2) FLUORESCENT ORANGE STRIPES ALTERNATING WITH A MINIMUM OF TWO (2) WHITE STRIPES. THESE STRIPES SHALL CONSIST OF RETROREFLECTIVE SHEETING.
 BASE SHALL WEIGH 30 LBS. OR MORE.

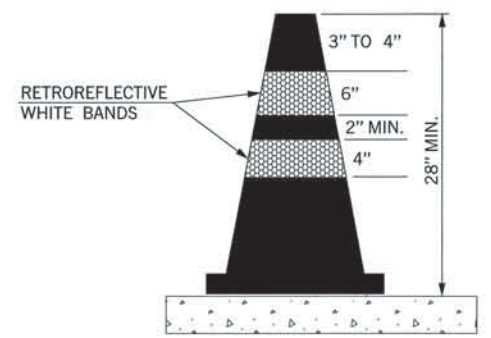

CONE

NOTES:

CONES USED ON HIGH SPEED ROADWAYS, ON ALL HIGHWAYS DURING NIGHTTIME, OR WHENEVER MORE CONSPICUOUS GUIDANCE IS NEEDED SHALL BE A MINIMUM OF 28 INCHES HIGH.
 CONES SHALL BE PREDOMINANTLY ORANGE, WITH WHITE RETROREFLECTIVE SHEETING.

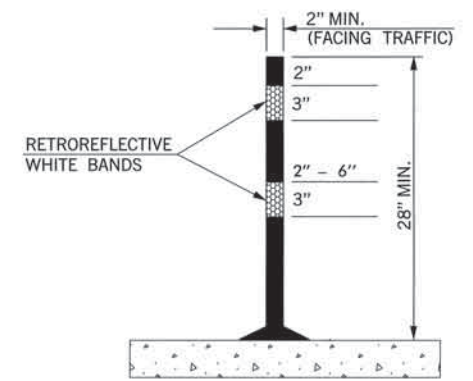

TUBE CHANNELIZER

NOTES:

TUBE CHANNELIZERS USED ON HIGH SPEED ROADWAYS, ON ALL HIGHWAYS DURING NIGHTTIME, OR WHENEVER MORE CONSPICUOUS GUIDANCE IS NEEDED SHALL BE A MINIMUM OF 28 INCHES HIGH.
 TUBE CHANNELIZERS SHALL BE PREDOMINANTLY ORANGE, WITH WHITE RETROREFLECTIVE SHEETING.

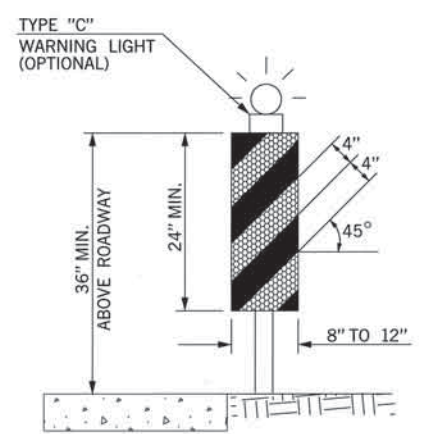

VERTICAL PANEL W/O DROP OFF

NOTES:

PANEL STRIPE WIDTHS SHALL BE 6 INCHES EXCEPT WHERE PANEL LENGTHS ARE LESS THAN 36 INCHES, THEN 4 INCH WIDE STRIPES MAY BE USED.
 MARKINGS FOR VERTICAL PANELS SHALL BE ALTERNATING FLUORESCENT ORANGE AND WHITE RETROREFLECTORIZED STRIPES (SLOPING DOWNWARD AT AN ANGLE OF 45 DEGREES IN THE DIRECTION TRAFFIC IS TO PASS).
 SHALL HAVE A MINIMUM OF TWO (2) FULL FLUORESCENT ORANGE STRIPES.

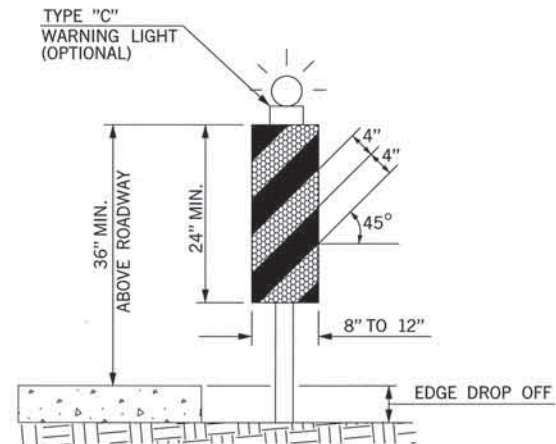

VERTICAL PANEL W/DROP OFF

ON UNDIVIDED HIGHWAYS, VERTICAL PANELS SHALL HAVE A MINIMUM OF 192 SQUARE INCHES OF RETROREFLECTIVE SHEETING ON EACH PANEL (FRONT AND BACK). WHEN USED ON HIGH SPEED ROADWAYS, VERTICAL PANELS SHALL HAVE MINIMUM OF 270 SQUARE INCHES OF RETROREFLECTIVE SHEETING ON EACH PANEL (FRONT AND BACK). THIS SHALL CONSTITUTE ONE (1) COMPLETE VERTICAL PANEL.
 ON DIVIDED HIGHWAYS A VERTICAL PANEL MAY HAVE SHEETING ON ONLY ONE SIDE.

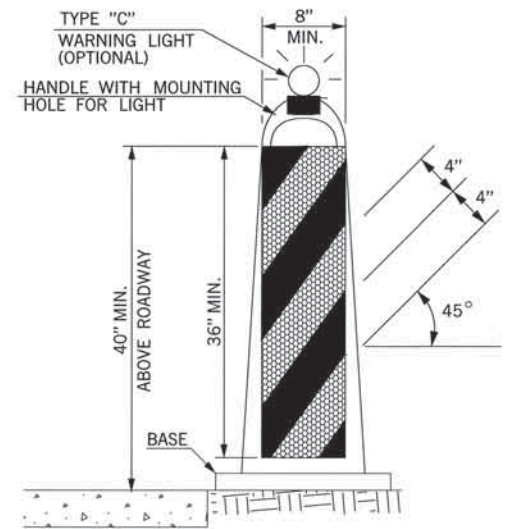

STACKABLE VERTICAL PANEL

NOTES:

(1) VERTICAL PANEL SIGNS SHALL BE MOUNTED BACK TO BACK WHEN USED FOR TWO-WAY TRAFFIC.
 (2) BASE SHALL BE NO LARGER THAN 28" LONG BY 20" WIDE, AND 2" THICK.
 (3) BASE SHALL WEIGHT 30 LBS. OR MORE.
 (4) THESE DEVICES SHALL BE CONSTRUCTED OF A MATERIAL THAT CAN BE STRUCK WITHOUT DAMAGING VEHICLES ON IMPACT.

KEY:

	FLUORESCENT ORANGE (REFLECTORIZED)
	WHITE (REFLECTORIZED)

BASIS OF PAYMENT		
ITEM NO.	ITEM	UNIT
880(D)	VERTICAL PANEL	SD
880(E)	WARNING LIGHTS	SD
880(F)	DRUMS	SD
880(G)	TUBE CHANNELIZERS	SD
880(H)	CONES	SD
880(I)	CHANNELIZER CONES	SD



APPROVED BY TRAFFIC ENGINEER: *[Signature]* DATE: 3/21/11

TRAFFIC STANDARD
 CHANNELIZING DEVICES

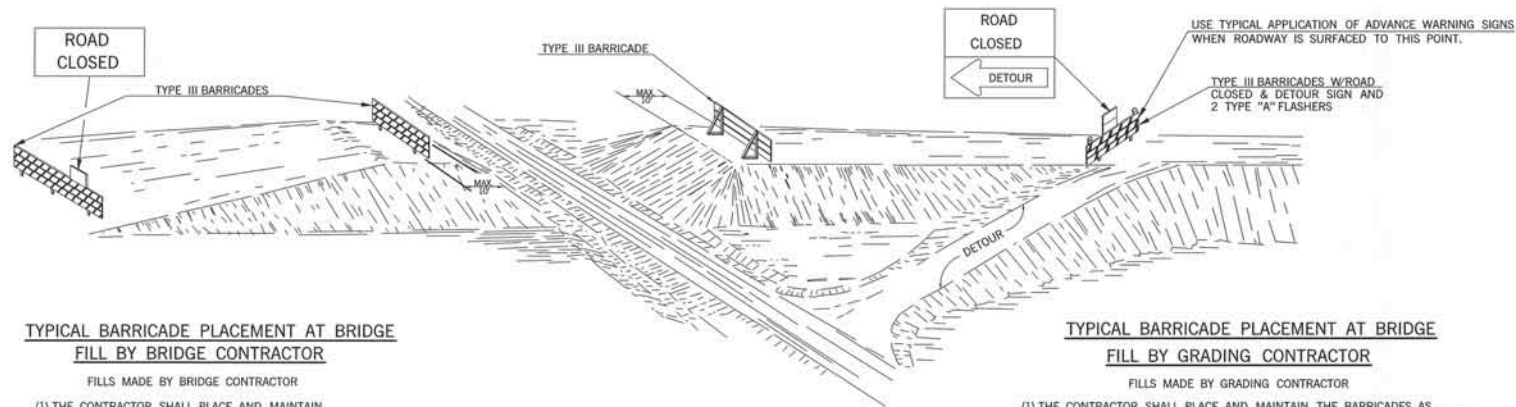

TYPICAL BARRICADE PLACEMENT AT BRIDGE FILL BY BRIDGE CONTRACTOR

- FILLS MADE BY BRIDGE CONTRACTOR
- (1) THE CONTRACTOR SHALL PLACE AND MAINTAIN THE BARRICADES AS SHOWN UNTIL THEY ARE NO LONGER NEEDED.
 - (2) THE CONTRACTOR SHALL NOTIFY THE ENGINEER PRIOR TO REMOVAL OF THE BARRICADES.
 - (3) THE ENGINEER SHALL NOTIFY THE GRADING CONTRACTOR TO FURNISH AND ERECT HIS BARRICADES "IMMEDIATELY" AFTER THE BRIDGE CONTRACTOR REMOVES HIS BARRICADES. THE GRADING CONTRACTOR SHALL MAINTAIN HIS BARRICADES UNTIL FINAL INSPECTION OR UNTIL THEY ARE NO LONGER NEEDED.
 - (4) BARRICADES AT BRIDGE FILL SHALL BE IN PLACE AND MAINTAINED AT ALL TIMES UNTIL OPENED TO TRAFFIC. HOWEVER, BARRICADES MAY BE REMOVED OR ADJUSTED, AS NEEDED, TO ALLOW ACCESS TO THE WORK AREA.

TYPICAL BARRICADE PLACEMENT AT BRIDGE FILL BY GRADING CONTRACTOR

- FILLS MADE BY GRADING CONTRACTOR
- (1) THE CONTRACTOR SHALL PLACE AND MAINTAIN THE BARRICADES AS SHOWN UNTIL FINAL INSPECTION OR UNTIL THEY ARE NO LONGER NEEDED.
 - (2) THE CONTRACTOR SHALL NOTIFY THE ENGINEER PRIOR TO REMOVAL OF THE BARRICADES.
 - (3) IF THE BRIDGE WORK ORDER IS ISSUED PRIOR TO COMPLETION OF THE GRADING CONTRACT, THE BRIDGE CONTRACTOR SHALL MAKE ARRANGEMENTS WITH THE GRADING CONTRACTOR TO ASSUME RESPONSIBILITY FOR PROTECTION OF THE BRIDGE WORK AREA. THIS WILL INCLUDE FURNISHING, INSTALLING, AND MAINTAINING ALL BARRICADES AND SIGNS NECESSARY TO PROVIDE THAT PROTECTION UNTIL THE BRIDGE IS COMPLETED AND THE FINAL INSPECTION IS COMPLETED.
 - (4) IF THE BRIDGE WORK ORDER HAS NOT BEEN ISSUED PRIOR TO THE FINAL INSPECTION OF THE GRADING, THEN THE GRADING CONTRACTOR SHALL MAKE ARRANGEMENTS WITH THE OKLAHOMA DEPARTMENT OF TRANSPORTATION FOR STATE FORCES TO SUPPLY, INSTALL AND MAINTAIN ANY NECESSARY TRAFFIC CONTROL DEVICES NEEDED TO PROTECT THE WORK AREA. THESE STATE OWNED DEVICES SHALL REMAIN IN PLACE UNTIL SUCH TIME THAT THE BRIDGE WORK ORDER IS ISSUED. AT THAT TIME THE BRIDGE CONTRACTOR SHALL ASSUME RESPONSIBILITY FOR TRAFFIC CONTROL AND REPLACE THE STATE OWNED DEVICES WITH HIS OWN.
 - (5) SUFFICIENT NUMBER OF TYPE II BARRICADES WITH SIGNS SHALL BE USED TO COMPLETELY CLOSE THE WORK AREA TO THROUGH TRAFFIC.
 - (6) BARRICADES AT BRIDGE FILL SHALL BE IN PLACE AND MAINTAINED AT ALL TIMES UNTIL OPENED TO TRAFFIC. HOWEVER, BARRICADES MAY BE REMOVED OR ADJUSTED, AS NEEDED, TO ALLOW ACCESS TO THE WORK AREA.

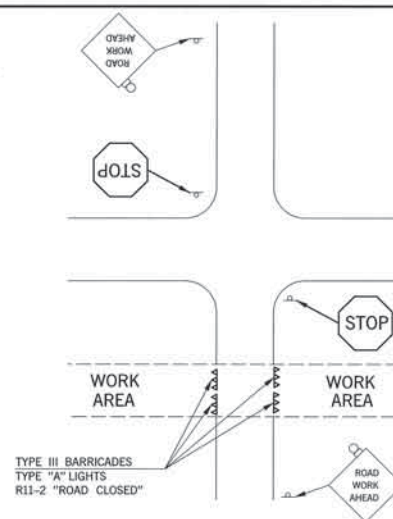

TYPICAL SIGN PLACEMENT FOR INTERSECTING ROADS AND STREETS

DESCRIPTION	REVISIONS	DATE
MODIFIED NOTE		3/16/2011
ADD "NO CELL PHONE" USAGE IN WORK ZONE DISTANCE SIGN TO WARNING SIGNS		4/2/2013

- NOTES:
- (1) SIGNS SHOWN FOR ONE DIRECTION OF TRAVEL ONLY.
 - (2) FLASHING WARNING LIGHTS SHALL BE USED TO CALL ATTENTION TO THE EARLY WARNING SIGNS.
 - (3) WARNING LIGHTS SHOULD BE USED TO MARK CHANNELIZING DEVICES AT NIGHT AS NEEDED.
 - (4) PLACEMENT OF TYPE III BARRICADES SHALL BE APPROVED BY THE ENGINEER.
 - (5) TYPE II BARRICADES, DRUMS AND/OR VERTICAL PANELS MAY BE SUBSTITUTED FOR TYPE III BARRICADES TO AVOID OBSTRUCTING THE MOTORIST'S VIEW.
 - (6) IF TWO OR MORE DRIVEWAYS ARE IN CLOSE PROXIMITY, THE BARRICADES BETWEEN THE DRIVEWAYS MAY BE OMITTED AT THE DISCRETION OF THE ENGINEER.
 - (7) THE "ROAD WORK AHEAD" SIGN, WHICH SERVES AS A GENERAL WARNING OF OBSTRUCTIONS OR RESTRICTIONS, SHALL BE LOCATED ON ALL INTERSECTING ROADS AND STREETS.

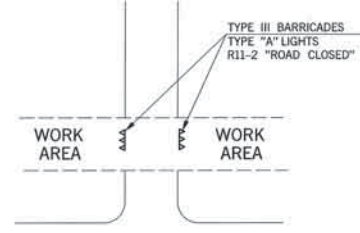

TYPICAL SIGN PLACEMENT FOR PRIVATE DRIVE OR RESIDENCE

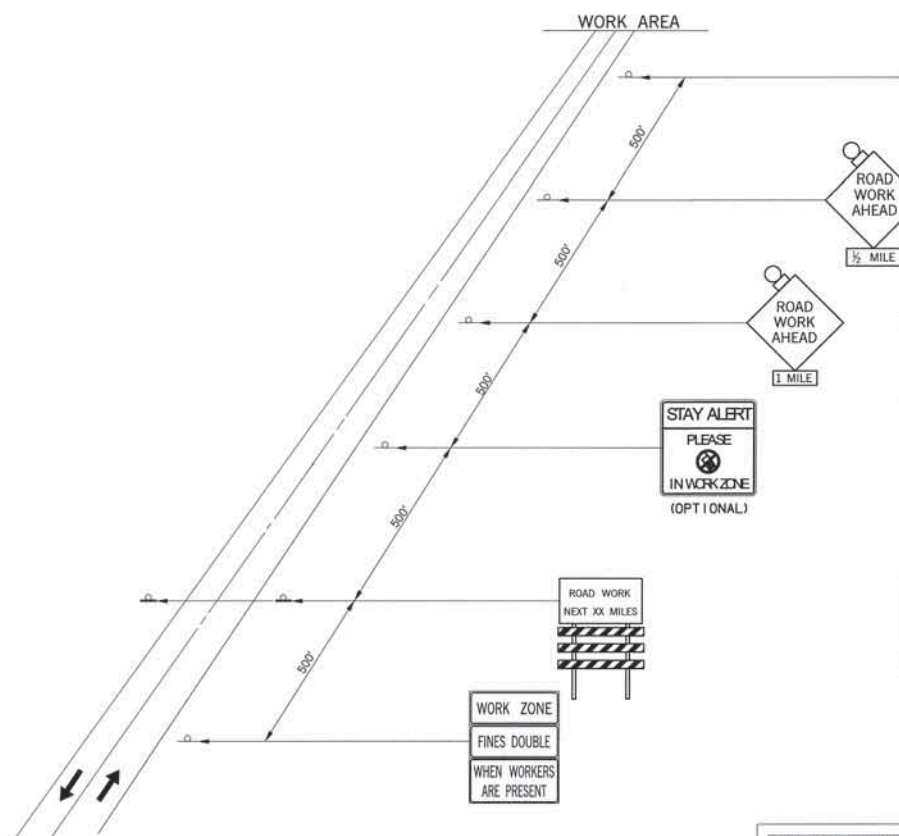

TYPICAL APPLICATION ADVANCE WARNING SIGNS ON 2-LANE HIGHWAY

TYPICAL CONSTRUCTION WARNING SIGNS WITH MESSAGES OTHER THAN DETAILED ON STANDARD DRAWINGS SHALL BE CONSTRUCTED USING THE LARGEST POSSIBLE LETTER SIZE. SIGN SIZE AND COLOR SHALL BE THE SAME AS OTHER CONSTRUCTION WARNING SIGNS USED FOR SIMILAR CONDITIONS.

FINES DOUBLE IN WORK ZONE SIGNS ARE TO BE USED ONLY ON STATE OR FEDERAL HIGHWAYS WHERE THE SPEED LIMIT IS REDUCED OR AS DIRECTED BY THE ENGINEER.

PROJECTS WITH WORK LIMITS OF 1.0 MILES OR MORE IN LENGTH WILL REQUIRE THE Q20-1A SIGN. THE SIGN SHALL BE MOUNTED AS SHOWN ON TCS4-1 (LATEST REVISION).

WARNING SIGNS SHOWN ARE "ADVANCE" WARNING SIGNS AND ARE REQUIRED ON ALL STATE HIGHWAYS. ADDITIONAL WARNING SIGNS MAY BE REQUIRED WITHIN THE PROJECT LIMITS TO WARN DRIVERS OF SPECIFIC HAZARDS. ADVANCE "WARNING SIGNS" MAY CHANGE AS CONDITIONS CHANGE OR AS DIRECTED BY THE ENGINEER.

PROJECT WORK OF 1.0 MILE OR MORE IN LENGTH WILL REQUIRE SIGNS CS-14 AND R2-1 TO BE PLACED EVERY 1/2 MILE THROUGH WORK ZONE.

ROAD TYPE	DISTANCE BETWEEN SIGNS SHALL BE A (MIN.)		
	A (FT)	B (FT)	C (FT)
URBAN (LOW SPEED)	100	100	100
URBAN (HIGH SPEED)	350	350	350
RURAL	500	500	500
EXPRESSWAY /FREEWAY	1,000	1,500	2,640

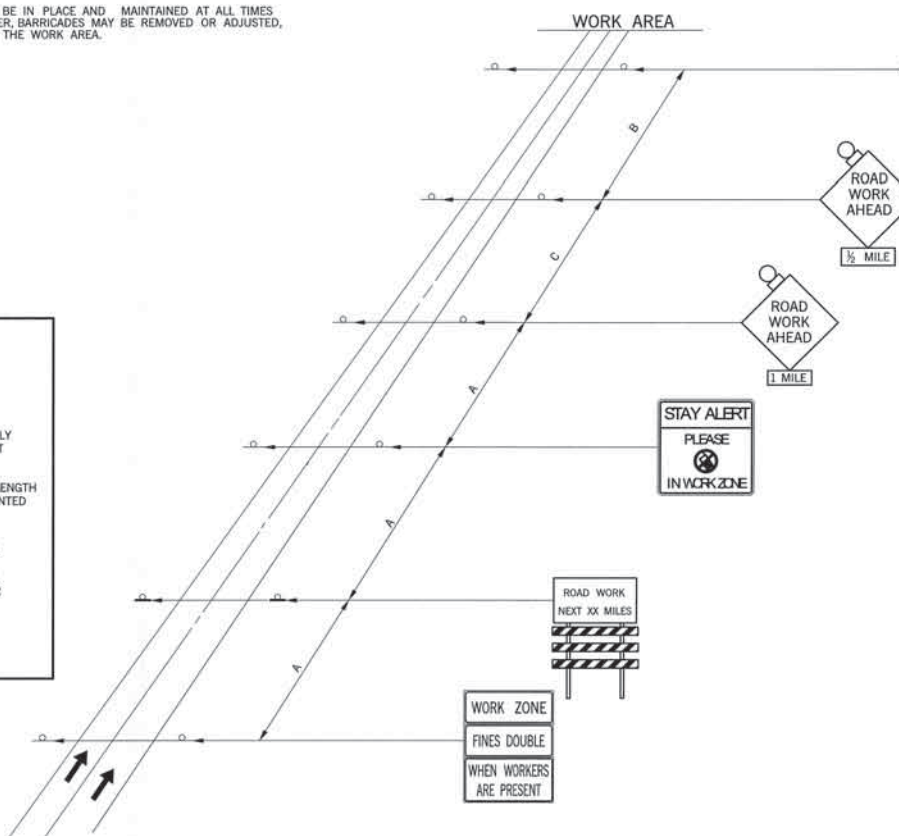

TYPICAL APPLICATION ADVANCE WARNING SIGNS ON A DIVIDED HIGHWAY

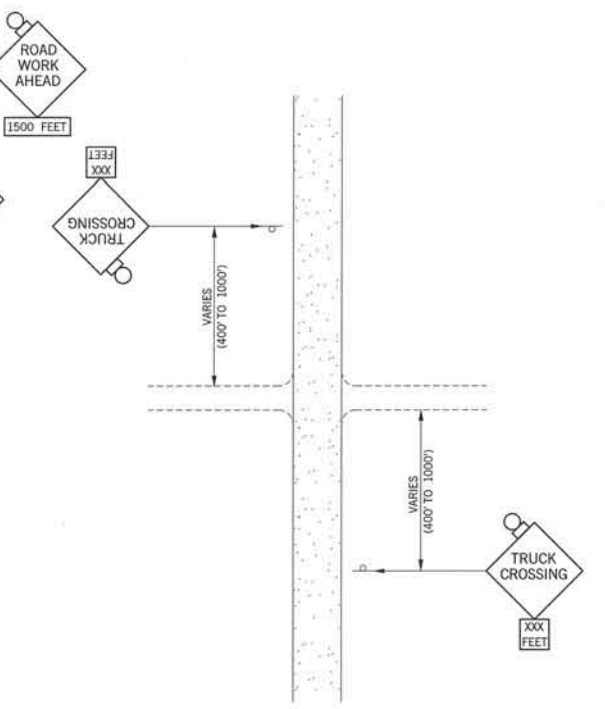

TYPICAL APPLICATION ADVANCE SIGNING WHERE TRUCKS ARE CROSSING



APPROVED BY TRAFFIC ENGINEER: *David S. ...* DATE: 4/18/2013

TRAFFIC STANDARD TRAFFIC CONTROL STANDARD PLACEMENT OF ADVANCE WARNING SIGNS

2009 SPECIFICATIONS

TCS7-1	02
	T-507

\$\$\$date\$\$\$

DESCRIPTION	REVISIONS	DATE



STOP

R1-1 30 x 30 5.18 SF
 R1-1E 36 x 36 7.46 SF
 R1-1F 48 x 48 13.26 SF

COLOR:
 LEGEND AND BORDER:
 WHITE (REFLECTORIZED)
 BACKGROUND:
 RED (TRANSPARENT REFLECTORIZED)



YIELD

R1-2 36 x 36 x 36 3.90 SF
 R1-2E 48 x 48 x 48 6.93 SF
 R1-2F 60 x 60 x 60 10.83 SF

COLOR:
 LEGEND AND BORDER:
 RED (TRANSPARENT REFLECTORIZED)
 BACKGROUND:
 WHITE (REFLECTORIZED)

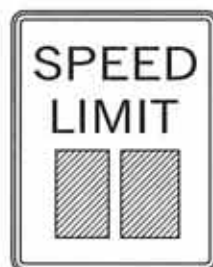

SPEED LIMIT

R2-1()^{SPEED} 24 x 30 5.00 SF
 R2-1E() 36 x 48 12.00 SF
 R2-1F() 48 x 60 20.00 SF

COLOR:
 LEGEND AND BORDER:
 BLACK (NON-REFLECTORIZED)
 BACKGROUND:
 WHITE (REFLECTORIZED)



NO RIGHT TURN

R3-1 24 x 24 4.00 SF
 R3-1E 36 x 36 9.00 SF
 R3-1F 48 x 48 16.00 SF

COLOR:
 ARROW AND BORDER:
 BLACK (NON-REFLECTORIZED)
 CIRCLE AND DIAGONAL:
 RED (TRANSPARENT REFLECTORIZED)
 BACKGROUND:
 WHITE (REFLECTORIZED)



NO LEFT TURN

R3-2 24 x 24 4.00 SF
 R3-2E 36 x 36 9.00 SF
 R3-2F 48 x 48 16.00 SF

COLOR:
 ARROW AND BORDER:
 BLACK (NON-REFLECTORIZED)
 CIRCLE AND DIAGONAL:
 RED (TRANSPARENT REFLECTORIZED)
 BACKGROUND:
 WHITE (REFLECTORIZED)



KEEP RIGHT SIGN

R4-7 24 x 30 5.00 SF
 R4-7E 36 x 48 12.00 SF
 R4-7F 48 x 60 20.00 SF

COLOR:
 LEGEND AND BORDER:
 BLACK (NON-REFLECTORIZED)
 BACKGROUND:
 WHITE (REFLECTORIZED)



KEEP LEFT SIGN

R4-8 24 x 30 5.00 SF
 R4-8E 36 x 48 12.00 SF
 R4-8F 48 x 60 20.00 SF

COLOR:
 LEGEND AND BORDER:
 BLACK (NON-REFLECTORIZED)
 BACKGROUND:
 WHITE (REFLECTORIZED)



KEEP RIGHT

R4-7a(R) 24 x 30 5.00 SF
 R4-7a(R)E 36 x 48 12.00 SF
 R4-7a(R)F 48 x 60 20.00 SF

COLOR:
 LEGEND AND BORDER:
 BLACK (NON-REFLECTORIZED)
 BACKGROUND:
 WHITE (REFLECTORIZED)



KEEP LEFT

R4-7a(L) 24 x 30 5.00 SF
 R4-7a(L)E 36 x 48 12.00 SF
 R4-7a(L)F 48 x 60 20.00 SF

COLOR:
 LEGEND AND BORDER:
 BLACK (NON-REFLECTORIZED)
 BACKGROUND:
 WHITE (REFLECTORIZED)



DO NOT ENTER

R5-1 30 x 30 6.25 SF
 R5-1E 36 x 36 9.00 SF
 R5-1F 48 x 48 16.00 SF

COLOR:
 SYMBOL: :
 RED (TRANSPARENT REFLECTORIZED)
 LEGEND AND BACKGROUND: :
 WHITE (REFLECTORIZED)

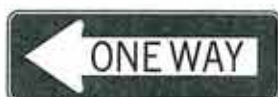

ONE WAY

R6-1(L) 36 x 12 3.00 SF
 R6-1E(L) 54 x 18 6.75 SF
 R6-1F(L) 54 x 18 6.75 SF

COLOR:
 ARROW AND BORDER:
 WHITE (NON-REFLECTORIZED)
 LEGEND AND BACKGROUND:
 BLACK (REFLECTORIZED)



ONE WAY

R6-1(R) 36 x 12 3.00 SF
 R6-1E(R) 54 x 18 6.75 SF
 R6-1F(R) 54 x 18 6.75 SF

COLOR:
 ARROW AND BORDER:
 WHITE (NON-REFLECTORIZED)
 LEGEND AND BACKGROUND:
 BLACK (REFLECTORIZED)



STOP HERE ON RED

R10-6 24 x 36 6.00 SF

COLOR:
 LEGEND AND BORDER:
 BLACK (NON-REFLECTORIZED)
 BACKGROUND:
 WHITE (REFLECTORIZED)

NOTES:
 WORD SIGNS MAY BE USED IF SYMBOL SIGNS ARE NOT AVAILABLE EITHER IN "STANDARD HIGHWAY SIGNS MANUAL" OR IN THE "MANUAL ON UNIFORM TRAFFIC CONTROL DEVICES" (MUTCD) (CURRENT EDITION).

BASIS OF PAYMENT		
ITEM NO.	ITEM	UNIT
880(B)	CONSTRUCTION SIGNS	SD



APPROVED BY
 TRAFFIC ENGINEER *Charles Smith* DATE 6/23/10
 TRAFFIC STANDARD

TRAFFIC CONTROL STANDARD
 CONSTRUCTION SIGNS



ROAD CLOSED

R11-2 48 x 30 10.00 SF

COLOR:
LEGEND AND BORDER:
BLACK (NON-REFLECTORIZED)
BACKGROUND:
WHITE (REFLECTORIZED)



LANE CLOSED

R11-2(LANE) 48 x 30 10.00 SF

COLOR:
LEGEND AND BORDER:
BLACK (NON-REFLECTORIZED)
BACKGROUND:
WHITE (REFLECTORIZED)

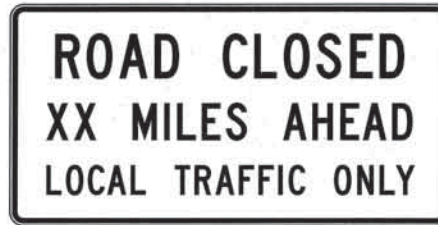

ROAD CLOSED XX MILES AHEAD

R11-3a 60 x 30 12.50 SF

COLOR:
LEGEND AND BORDER:
BLACK (NON-REFLECTORIZED)
BACKGROUND:
WHITE (REFLECTORIZED)

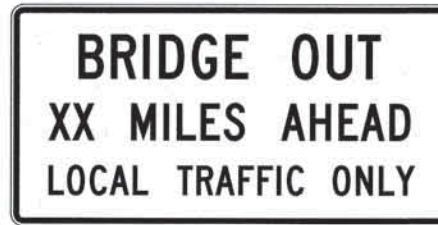

BRIDGE OUT XX MILES AHEAD

R11-3b 60 x 30 12.50 SF

COLOR:
LEGEND AND BORDER:
BLACK (NON-REFLECTORIZED)
BACKGROUND:
WHITE (REFLECTORIZED)



ROAD CLOSED TO THRU TRAFFIC

R11-4 60 x 30 12.50 SF

COLOR:
LEGEND AND BORDER:
BLACK (NON-REFLECTORIZED)
BACKGROUND:
WHITE (REFLECTORIZED)



DETOUR SIGN

M4-8 24 x 12 2.00 SF
M4-8E 30 x 15 3.13 SF

COLOR:
LEGEND AND BORDER:
BLACK (NON-REFLECTORIZED)
BACKGROUND:
FLUORESCENT ORANGE
(REFLECTORIZED)



DETOUR SIGN

M4-9(R) 30 x 24 5.00 SF
M4-9(R)E 48 x 36 12.00 SF
M4-9(R)F 60 x 48 20.00 SF

COLOR:
LEGEND AND BORDER:
BLACK (NON-REFLECTORIZED)
BACKGROUND:
FLUORESCENT ORANGE
(REFLECTORIZED)



DETOUR SIGN

M4-9(L) 30 x 24 5.00 SF
M4-9(L)E 48 x 36 12.00 SF
M4-9(L)F 60 x 48 20.00 SF

COLOR:
LEGEND AND BORDER:
BLACK (NON-REFLECTORIZED)
BACKGROUND:
FLUORESCENT ORANGE
(REFLECTORIZED)



DETOUR SIGN

M4-9(V) 30 x 24 5.00 SF
M4-9(V)E 48 x 36 12.00 SF
M4-9(V)F 60 x 48 20.00 SF

COLOR:
LEGEND AND BORDER:
BLACK (NON-REFLECTORIZED)
BACKGROUND:
FLUORESCENT ORANGE
(REFLECTORIZED)



DETOUR SIGN

M4-10(R) 48 x 18 6.00 SF

COLOR:
LEGEND AND BORDER:
BLACK (NON-REFLECTORIZED)
BACKGROUND:
FLUORESCENT ORANGE
(REFLECTORIZED)



DETOUR SIGN

M4-10(L) 48 x 18 6.00 SF

COLOR:
LEGEND AND BORDER:
BLACK (NON-REFLECTORIZED)
BACKGROUND:
FLUORESCENT ORANGE
(REFLECTORIZED)

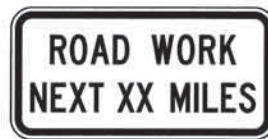

ROAD WORK NEXT XX MILES SIGN

G20-1A 36 x 18 4.50 SF

COLOR:
LEGEND AND BORDER:
BLACK (NON-REFLECTORIZED)
BACKGROUND:
FLUORESCENT ORANGE
(REFLECTORIZED)

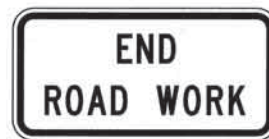

END ROAD WORK SIGN

G20-2A 36 x 18 4.50 SF

COLOR:
LEGEND AND BORDER:
BLACK (NON-REFLECTORIZED)
BACKGROUND:
FLUORESCENT ORANGE
(REFLECTORIZED)

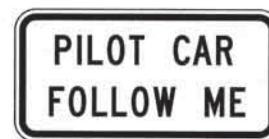

PILOT CAR FOLLOW ME SIGN

G20-4 36 x 18 4.50 SF

COLOR:
LEGEND AND BORDER:
BLACK (NON-REFLECTORIZED)
BACKGROUND:
FLUORESCENT ORANGE
(REFLECTORIZED)

NOTES:
WORD SIGNS MAY BE USED IF SYMBOL SIGNS ARE NOT AVAILABLE EITHER IN "STANDARD HIGHWAY SIGNS MANUAL" OR IN THE "MANUAL ON UNIFORM TRAFFIC CONTROL DEVICES" (MUTCD) (CURRENT EDITION).

ALL DIAMOND SHAPE CONSTRUCTION WARNING SIGNS SHALL BE 48 INCHES X 48 INCHES UNLESS OTHERWISE NOTED IN THE PLANS.

BASIS OF PAYMENT		
ITEM NO.	ITEM	UNIT
880(B)	CONSTRUCTION SIGNS	SD



APPROVED BY
TRAFFIC ENGINEER: *David Gandy* DATE: 3/21/11

TRAFFIC STANDARD
TRAFFIC CONTROL STANDARD
CONSTRUCTION SIGNS

T:\Traffic\TRAFFIC STD CURRENT\2009\DRAWINGS\TCS11-1-01 1511.dgn 10:38:39 AM 7/19/2010 R:\TRAFFIC_PLOT\erohy.pan R:\TRAFFIC_PLOT\bw.tbl

DESCRIPTION	REVISIONS	DATE
CHANGE DESIGN NUMBER		07/19/10



CHEVRON

W1-8 18 x 24 3.00 SF
 W1-8E 30 x 36 7.50 SF
 W1-8F 36 x 48 12.00 SF

COLOR:
 SYMBOL AND BORDER:
 BLACK (NON-REFLECTORIZED)
 BACKGROUND:
 FLUORESCENT ORANGE (REFLECTORIZED)



STOP AHEAD

W3-1 48 x 48 16.00 SF

COLOR:
 BORDER AND ARROW:
 BLACK (NON-REFLECTORIZED)
 BACKGROUND:
 FLUORESCENT ORANGE (REFLECTORIZED)
 SYMBOL:
 WHITE BORDER ON RED BACKGROUND (REFLECTORIZED)



YIELD AHEAD

W3-2 48 x 48 16.00 SF

COLOR:
 BORDER AND ARROW:
 BLACK (NON-REFLECTORIZED)
 BACKGROUND:
 FLUORESCENT ORANGE (REFLECTORIZED)
 SYMBOL:
 WHITE BORDER ON RED BACKGROUND (REFLECTORIZED)



SIGNAL AHEAD

W3-3 48 x 48 16.00 SF

COLOR:
 SYMBOL AND BORDER:
 BLACK (NON-REFLECTORIZED)
 BACKGROUND:
 FLUORESCENT ORANGE (REFLECTORIZED)
 R = RED (REFLECTORIZED)
 Y = YELLOW (REFLECTORIZED)
 G = GREEN (REFLECTORIZED)



BE PREPARED TO STOP

BE PREPARED TO STOP SIGN

W3-4 48 x 48 16.00 SF

COLOR:
 LEGEND AND BORDER:
 BLACK (NON-REFLECTORIZED)
 BACKGROUND:
 FLUORESCENT ORANGE (REFLECTORIZED)



SPEED REDUCTION

W3-5 48 x 48 16.00 SF

COLOR:
 BORDER AND ARROW:
 BLACK (NON-REFLECTORIZED)
 BACKGROUND:
 FLUORESCENT ORANGE (REFLECTORIZED)
 SYMBOL:
 BLACK BORDER AND TEXT ON WHITE BACKGROUND (REFLECTORIZED)



LEFT LANE ENDS

W4-2(L) 48 x 48 16.00 SF

COLOR:
 SYMBOL AND BORDER:
 BLACK (NON-REFLECTORIZED)
 BACKGROUND:
 FLUORESCENT ORANGE (REFLECTORIZED)



RIGHT LANE ENDS

W4-2(R) 48 x 48 16.00 SF

COLOR:
 SYMBOL AND BORDER:
 BLACK (NON-REFLECTORIZED)
 BACKGROUND:
 FLUORESCENT ORANGE (REFLECTORIZED)



ROAD NARROWS

W5-1 48 x 48 16.00 SF

COLOR:
 SYMBOL AND BORDER:
 BLACK (NON-REFLECTORIZED)
 BACKGROUND:
 FLUORESCENT ORANGE (REFLECTORIZED)



NARROW BRIDGE

W5-2 48 x 48 16.00 SF

COLOR:
 SYMBOL AND BORDER:
 BLACK (NON-REFLECTORIZED)
 BACKGROUND:
 FLUORESCENT ORANGE (REFLECTORIZED)

NOTES:
 WORD SIGNS MAY BE USED IF SYMBOL SIGNS ARE NOT AVAILABLE EITHER IN "STANDARD HIGHWAY SIGNS MANUAL" OR IN THE "MANUAL ON UNIFORM TRAFFIC CONTROL DEVICES" (MUTCD) (CURRENT EDITION).

ALL DIAMOND SHAPE CONSTRUCTION WARNING SIGNS SHALL BE 48 INCHES X 48 INCHES UNLESS OTHERWISE NOTED IN THE PLANS.

* SUPPLEMENTAL SIGNS SHALL ONLY BE USED IN CONJUNCTION WITH DIAMOND SHAPE CONSTRUCTION WARNING SIGNS. THE SIZE OF SUPPLEMENTAL SIGNS SHALL BE APPROPRIATE FOR USE WITH A 48 INCH X 48 INCH WARNING SIGN UNLESS OTHERWISE NOTED IN THE PLANS.



ONE LANE BRIDGE

W5-3 48 x 48 16.00 SF

COLOR:
 SYMBOL AND BORDER:
 BLACK (NON-REFLECTORIZED)
 BACKGROUND:
 FLUORESCENT ORANGE (REFLECTORIZED)



DIVIDED HIGHWAY

W6-1 48 x 48 16.00 SF

COLOR:
 SYMBOL AND BORDER:
 BLACK (NON-REFLECTORIZED)
 BACKGROUND:
 FLUORESCENT ORANGE (REFLECTORIZED)



DIVIDED HIGHWAY

W6-2 48 x 48 16.00 SF

COLOR:
 SYMBOL AND BORDER:
 BLACK (NON-REFLECTORIZED)
 BACKGROUND:
 FLUORESCENT ORANGE (REFLECTORIZED)



TWO WAY TRAFFIC SIGN

W6-3 48 x 48 16.00 SF

COLOR:
 SYMBOL AND BORDER:
 BLACK (NON-REFLECTORIZED)
 BACKGROUND:
 FLUORESCENT ORANGE (REFLECTORIZED)

BASIS OF PAYMENT		
ITEM NO.	ITEM	UNIT
B80(B)	CONSTRUCTION SIGNS	SD



APPROVED BY TRAFFIC ENGINEER: *Chad J. Smith* DATE: 8/6/10

TRAFFIC STANDARD
 TRAFFIC CONTROL STANDARD
 CONSTRUCTION SIGNS



Dimensions are in Inches.tenths

SIGN NUMBER	CS-13
WIDTH x HGHT.	2'-0" x 1'-0"
BORDER WIDTH	0.63"
CORNER RADIUS	1.5"
MOUNTING	Ground
SIGN AREA	2.0 Sq.Ft.
BACKGROUND	TYPE: Reflective COLOR: FLO*
LEGEND BORDER	TYPE: Non-Reflective COLOR: Black

LETTER POSITIONS (X)					LENGTH	SERIESIZE
B	E	G	I	N		D 2000
4.8	8.2	11.3	14.9	16.5		14.4

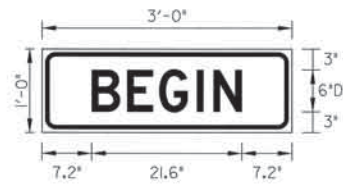

Dimensions are in Inches.tenths

SIGN NUMBER	CS-13E
WIDTH x HGHT.	3'-0" x 1'-0"
BORDER WIDTH	0.63"
CORNER RADIUS	1.5"
MOUNTING	Ground
SIGN AREA	3.0 Sq.Ft.
BACKGROUND	TYPE: Reflective COLOR: FLO*
LEGEND BORDER	TYPE: Non-Reflective COLOR: Black

LETTER POSITIONS (X)					LENGTH	SERIESIZE
B	E	G	I	N		D 2000
7.2	12.3	16.9	22.3	24.7		21.6



Dimensions are in Inches.tenths

SIGN NUMBER	CS-13F
WIDTH x HGHT.	4'-0" x 1'-6"
BORDER WIDTH	0.63"
CORNER RADIUS	1.5"
MOUNTING	Ground
SIGN AREA	6.0 Sq.Ft.
BACKGROUND	TYPE: Reflective COLOR: FLO*
LEGEND BORDER	TYPE: Non-Reflective COLOR: Black

LETTER POSITIONS (X)					LENGTH	SERIESIZE
B	E	G	I	N		E 2000
7.1	15.2	22.6	30.9	34.4		33.8

FLO* = FLUORESCENT ORANGE

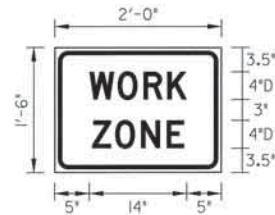

Dimensions are in Inches.tenths

SIGN NUMBER	CS-14
WIDTH x HGHT.	2'-0" x 1'-6"
BORDER WIDTH	0.63"
CORNER RADIUS	1.5"
MOUNTING	Ground
SIGN AREA	3.0 Sq.Ft.
BACKGROUND	TYPE: Reflective COLOR: FLO*
LEGEND BORDER	TYPE: Non-Reflective COLOR: Black

LETTER POSITIONS (X)					LENGTH	SERIESIZE
W	O	R	K			D 2000
5	9.1	12.8	16.2			14
Z	O	N	E			D 2000
5.4	8.7	12.5	16.1			13.2

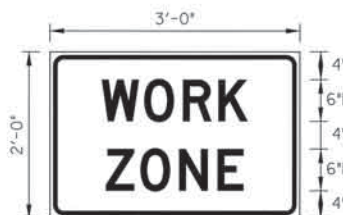

Dimensions are in Inches.tenths

SIGN NUMBER	CS-14E
WIDTH x HGHT.	3'-0" x 2'-0"
BORDER WIDTH	0.63"
CORNER RADIUS	1.5"
MOUNTING	Ground
SIGN AREA	6.0 Sq.Ft.
BACKGROUND	TYPE: Reflective COLOR: FLO*
LEGEND BORDER	TYPE: Non-Reflective COLOR: Black

LETTER POSITIONS (X)					LENGTH	SERIESIZE
W	O	R	K			D 2000
7.5	13.6	19.2	24.3			21
Z	O	N	E			D 2000
8.1	13.1	18.7	24.2			19.8

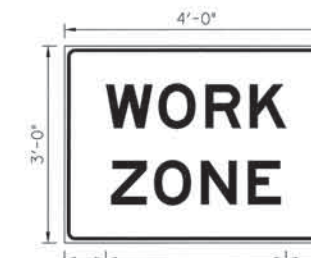

Dimensions are in Inches.tenths

SIGN NUMBER	CS-14F
WIDTH x HGHT.	4'-0" x 3'-0"
BORDER WIDTH	0.63"
CORNER RADIUS	1.5"
MOUNTING	Ground
SIGN AREA	12.0 Sq.Ft.
BACKGROUND	TYPE: Reflective COLOR: FLO*
LEGEND BORDER	TYPE: Non-Reflective COLOR: Black

LETTER POSITIONS (X)					LENGTH	SERIESIZE
W	O	R	K			E 2000
7.6	17.2	25.7	33.8			32.9
Z	O	N	E			E 2000
8.5	16.4	24.9	33.5			31

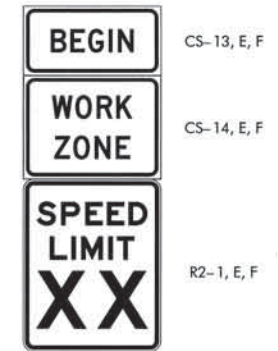

CONSTRUCTION
BEGIN WORK ZONE
SPEED LIMIT
ASSEMBLY

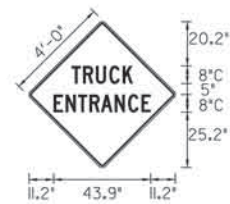

Dimensions are in Inches.tenths

SIGN NUMBER	CS-15
WIDTH x HGHT.	4'-0" x 4'-0"
BORDER WIDTH	0.75"
CORNER RADIUS	1.38"
MOUNTING	Ground
SIGN AREA	16.0 Sq.Ft.
BACKGROUND	TYPE: Reflective COLOR: Yellow
LEGEND BORDER	TYPE: Reflective COLOR: Black

LETTER POSITIONS (X)					LENGTH	SERIESIZE	
T	R	U	C	K		C 2000	
19.3	24.5	30.4	36.5	42.5		27.7	
E	N	T	R	A	N	C	E
11.2	16.7	22.3	27.5	32.7	38.9	45	51.1
							43.9

BASIS OF PAYMENT		
ITEM NO.	ITEM	UNIT
880(B)	CONSTRUCTION SIGNS	SD



APPROVED BY
TRAFFIC ENGINEER: *David Gandy* DATE: 3/2/11

TRAFFIC STANDARD
TRAFFIC CONTROL STANDARD
CONSTRUCTION SIGNS

DESCRIPTION	REVISIONS	DATE
-------------	-----------	------



SIGN NUMBER	CS-16
WIDTH x HGHT.	3'-0" x 1'-0"
BORDER WIDTH	0.63"
CORNER RADIUS	1.5"
MOUNTING	Ground
SIGN AREA	3.0 Sq.Ft.
BACKGROUND	TYPE: Reflective COLOR: Orange
LEGEND/BORDER	TYPE: Non-Reflective COLOR: Black

Dimensions are in inches, tenths

LETTER POSITIONS (X)										LENGTH	SERIESIZE
W	O	R	K	Z	O	N	E			C	2000
4.5	8	11.2	14.1	16.3	20.3	23.2	26.3	29.5		27	

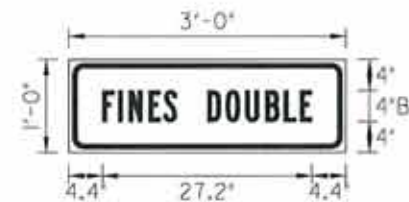

SIGN NUMBER	CS-17
WIDTH x HGHT.	3'-0" x 1'-0"
BORDER WIDTH	0.63"
CORNER RADIUS	1.5"
MOUNTING	Ground
SIGN AREA	3.0 Sq.Ft.
BACKGROUND	TYPE: Reflective COLOR: White
LEGEND/BORDER	TYPE: Non-Reflective COLOR: Black

Dimensions are in inches, tenths

LETTER POSITIONS (X)										LENGTH	SERIESIZE	
F	I	N	E	S	D	O	U	B	L	E	B	2000
4.4	6.5	7.9	10.5	12.4	14.1	18.1	20.5	23.1	25.7	28	30.1	27.2



SIGN NUMBER	CS-18
WIDTH x HGHT.	3'-0" x 1'-6"
BORDER WIDTH	0.63"
CORNER RADIUS	1.5"
MOUNTING	Ground
SIGN AREA	4.5 Sq.Ft.
BACKGROUND	TYPE: Reflective COLOR: White
LEGEND/BORDER	TYPE: Non-Reflective COLOR: Black

Dimensions are in inches, tenths

LETTER POSITIONS (X)										LENGTH	SERIESIZE		
W	H	E	N	W	O	R	K	E	R	S	B	2000	
3	6.1	8.7	10.9	12.6	16.6	19.6	22.2	24.6	27	29.1	31.3	30	
A	R	E	P	R	E	S	E	N	T			B	2000
5.3	8	10.3	11.9	15.9	18.1	20.5	22.4	24.8	26.9	29.2		25.5	

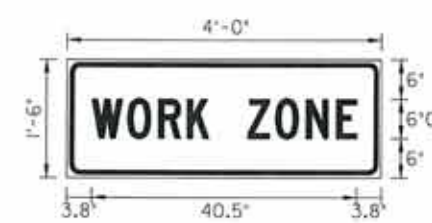

SIGN NUMBER	CS-16E
WIDTH x HGHT.	4'-0" x 1'-6"
BORDER WIDTH	0.63"
CORNER RADIUS	1.5"
MOUNTING	Ground
SIGN AREA	6.0 Sq.Ft.
BACKGROUND	TYPE: Reflective COLOR: Orange
LEGEND/BORDER	TYPE: Non-Reflective COLOR: Black

Dimensions are in inches, tenths

LETTER POSITIONS (X)										LENGTH	SERIESIZE
W	O	R	K	Z	O	N	E			C	2000
3.8	9	13.8	18.2	21.5	27.5	31.8	36.5	41.2		40.5	

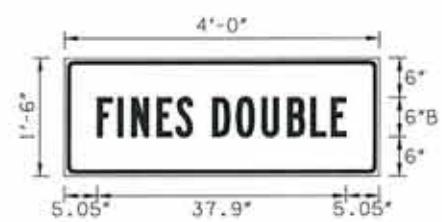

SIGN NUMBER	CS-17E
WIDTH x HGHT.	4'-0" x 1'-6"
BORDER WIDTH	0.63"
CORNER RADIUS	1.5"
MOUNTING	Ground
SIGN AREA	6.0 Sq.Ft.
BACKGROUND	TYPE: Reflective COLOR: White
LEGEND/BORDER	TYPE: Non-Reflective COLOR: Black

Dimensions are in inches, tenths

LETTER POSITIONS (X)										LENGTH	SERIESIZE	
F	I	N	E	S	D	O	U	B	L	E	B	2000
5.1	8.2	10.3	14.2	17.1	22.7	26.2	30.1	34	37.5	40.7	37.9	



SIGN NUMBER	CS-18E
WIDTH x HGHT.	4'-0" x 2'-0"
BORDER WIDTH	0.63"
CORNER RADIUS	1.13"
MOUNTING	Ground
SIGN AREA	8.0 Sq.Ft.
BACKGROUND	TYPE: Reflective COLOR: White
LEGEND/BORDER	TYPE: Non-Reflective COLOR: Black

Dimensions are in inches, tenths

LETTER POSITIONS (X)										LENGTH	SERIESIZE		
W	H	E	N	W	O	R	K	E	R	S	B	2000	
3	7.7	11.6	14.9	20.4	24.9	28.8	32.4	36	39.2	42.4	41.9		
A	R	E	P	R	E	S	E	N	T			B	2000
6.4	10.5	14	19.3	22.7	26.3	29.1	32.7	35.9	39.3		35.2		

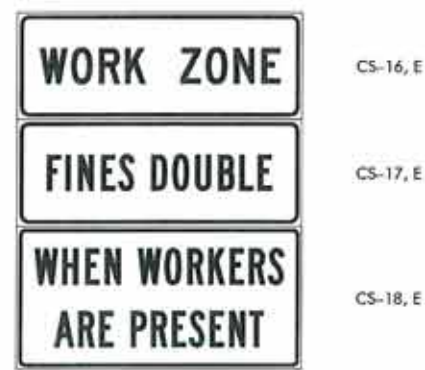

CONSTRUCTION FINES DOUBLE ASSEMBLY

BASIS OF PAYMENT		
ITEM NO.	ITEM	UNIT
880(B)	CONSTRUCTION SIGNS	SD



APPROVED BY TRAFFIC ENGINEER *David Smith* DATE 6/23/10

TRAFFIC STANDARD
TRAFFIC CONTROL STANDARD
CONSTRUCTION SIGNS

TRPC36 D:\usr2\2009_Standards_TC\1520.dgn 1:36:29 PM 6/18/2010 R:\TRAFF_PLOT\aroyh.psn R:\TRAFF_PLOT\bw.tbl